

Panasonic®

Operating Instructions Air Conditioner

Model No.

Indoor Unit

CS-S9JKUW-1

CS-S12JKUW-1

CS-S18JKU-1

CS-S22JKU-1

Single Split
Outdoor Unit

CU-S9JKU-1

CU-S12JKU-1

CU-S18JKU-1

CU-S22JKU-1

Multi Split
Outdoor Unit

CU-2S18JBU-1



Before operating the unit, read these operating instructions thoroughly and keep them for future reference.



QUICK GUIDE

© Panasonic HA Air-Conditioning (M) Sdn. Bhd. 2010.
Unauthorized copying and distribution is a violation
of law.

F567673

Thank you for purchasing
Panasonic Air Conditioner

TABLE OF CONTENTS

SAFETY PRECAUTIONS 2~3

MULTI AIR CONDITIONER SYSTEM 4

INDOOR UNIT 5

REMOTE CONTROL 6~7

TROUBLESHOOTING 8

INFORMATION 9

QUICK GUIDE BACK COVER

NOTE

The illustrations in this manual are for explanation purposes only and may differ from the actual unit. It is subjected to change without notice for future improvement.

OPERATION CONDITION

Use this air conditioner under the following temperature range

Temperature (°F)		Indoor	
		*DBT	*WBT
COOLING	Max.	89.6	73.4
	Min.	60.8	51.8

Temperature (°F)		Outdoor	
		*DBT	*WBT
COOLING	Max.	109.4	78.8
	Min.	60.8	51.8

*DBT: Dry bulb temperature

*WBT: Wet bulb temperature

SAFETY PRECAUTIONS

To prevent personal injury, injury to others, or property damage, please comply with the following.
Incorrect operation due to failure to follow instructions below may cause harm or damage, the seriousness of which is classified as below:



WARNING This sign warns of death or serious injury.



CAUTION This sign warns of injury or damage to property.

The instructions to be followed are classified by the following symbols:



This symbol denotes an action that is **PROHIBITED**.



These symbols denote an actions that is **COMPULSORY**.



WARNING

INDOOR UNIT AND OUTDOOR UNIT



This appliance is not intended for use by persons (including children) with reduced physical, sensory or mental capabilities, or lack of experience and knowledge, unless they have been given supervision or instruction concerning use of the appliance by a person responsible for their safety. Children should be supervised to ensure that they do not play with the appliance.

Please consult authorized dealer or specialist to repair, install, remove and reinstall the unit. Improper installation and handling will cause leakage, electric shock or fire.



Do not install the unit in a potentially explosive or flammable atmosphere. Failure to do so could result in fire.

Do not insert your fingers or other objects into the air conditioner indoor or outdoor unit, rotating parts may cause injury.



Do not touch the outdoor unit during lightning, it may cause electric shock.

REMOTE CONTROL



Do not allow infants and small children to play with the remote control to prevent them from accidentally swallowing the batteries.



WARNING

POWER SUPPLY



Do not use modified cord, joint cord, extension cord or unspecified cord to prevent overheating and fire.



Do not share the same power outlet with other equipment to prevent overheating and fire.

Do not operate with wet hands to prevent electric shock.



If the supply cord is damage, it must be replaced by the manufacturer, its service agent or similarly qualified persons in order to avoid a hazard.

It is strongly recommended to be installed with Earth Leakage Circuit Breaker (ELCB) or Residual Current Device (RCD) to prevent electric shock or fire.



This equipment must be earthed to prevent electrical shock or fire.



Prevent electric shock by switching off the power supply when:

- Before cleaning or servicing.
- Extended non-use.
- Abnormally strong lightning activity.



Stop using the product when any abnormality/failure occurs and disconnect the power plug or turn off the power switch and breaker. (Risk of smoke/fire/electric shock)

Examples of abnormality/failure

- The ELCB trips frequently.
- Burning smell is observed.
- Abnormal noise or vibration of the unit is observed.
- Water leaks from the indoor unit.
- Power cord or plug becomes abnormally hot.
- Fan speed cannot be controlled.
- The unit stops running immediately even if it is switched on for operation.
- The fan does not stop even if the operation is stopped.

Contact immediately your local dealer for maintenance/repair.



CAUTION

INDOOR UNIT AND OUTDOOR UNIT



Do not wash the indoor unit with water, benzene, thinner or scouring powder.

Do not use for other purpose such as preservation of food.

Do not use any combustible equipment in front of the airflow outlet to avoid fire.

Do not expose yourself directly to cold air for a long period.

Do not sit or step on the unit, you may fall down accidentally.



Do not touch the sharp aluminium fin, sharp parts may cause injury.



Do not switch ON the indoor unit when waxing the floor. After waxing, aerate the room properly before operating the unit.

Do not install the unit in oily and smoky areas.



Ensure drainage pipe is connected properly. Otherwise, leakage may occur.

Aerate the room regularly.

After long period of use, make sure the installation rack is not deteriorate to prevent the unit from falling down.

REMOTE CONTROL



Do not use rechargeable (Ni-Cd) batteries. It may damage the remote control.



Remove the batteries if the unit is not going to be used for a long period of time.

New batteries of the same type must be inserted following the polarity stated to prevent malfunction of the remote control.

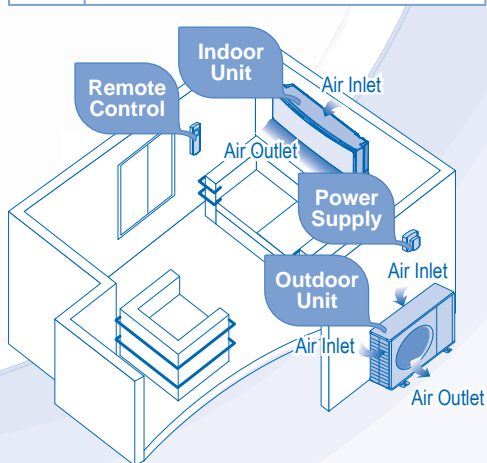

MULTI AIR CONDITIONER SYSTEM

Multi Split Outdoor Unit
(CU-2S18JBU-1)

DEFINITION

Multi air conditioner systems save space by letting you connect multiple indoor units to a single outdoor unit.

INDOOR UNIT

- It is possible to operate the indoor units individually or simultaneously. The operation mode priority is given to the first unit that turned on.
- During operation, heating and cooling mode could not be activated at the same time for different indoor unit. The power indicator blinks to indicate the indoor unit is standing by for different operation mode.

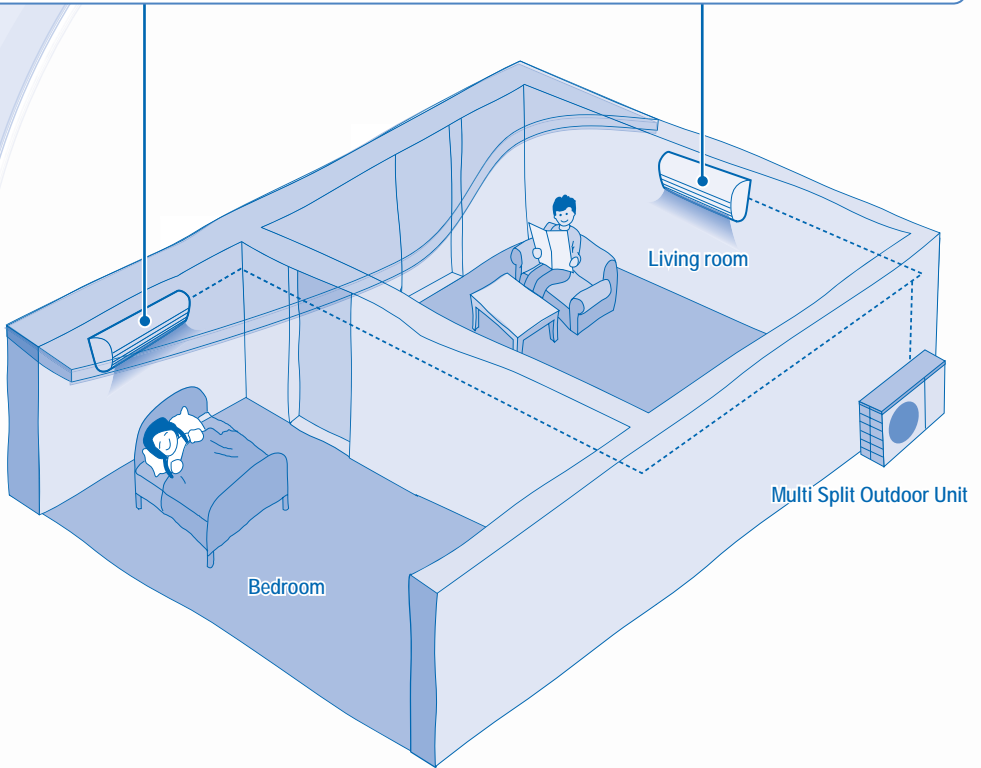

POWER SUPPLY

	Models Number	Time Delay Fuse	Rated Volts
Single Split System	CS-S9JKUW-1 / CU-S9JKU-1	15 Amps	208/230V
	CS-S12JKUW-1 / CS-S9JKU-1	15 Amps	
	CS-S18JKU-1 / CU-S18JKU-1	20 Amps	
	CS-S22JKU-1 / CU-S22JKU-1	25 Amps	
Multi Split System	CS-S9JKUW-1, CS-S9JKUW-1 / CU-2S18JBU-1	25 Amps	208/230V
	CS-S9JKUW-1, CS-S12JKUW-1 / CU-2S18JBU-1		
	CS-S12JKUW-1, CS-S12JKUW-1 / CU-2S18JBU-1		

INDOOR UNIT



CAUTION

- Switch off the power supply before cleaning.
- Do not touch the aluminium fin, sharp parts may cause injury.

CLEANING INSTRUCTIONS

- Do not use benzene, thinner or scouring powder.
- Use only soap (\approx pH7) or neutral household detergent.
- Do not use water hotter than 104°F.

HINT

- To ensure optimal performance of the unit, cleaning maintenance has to be carried out at regular intervals. Dirty unit may cause malfunction and you may see error code "H99". Please consult authorized dealer.

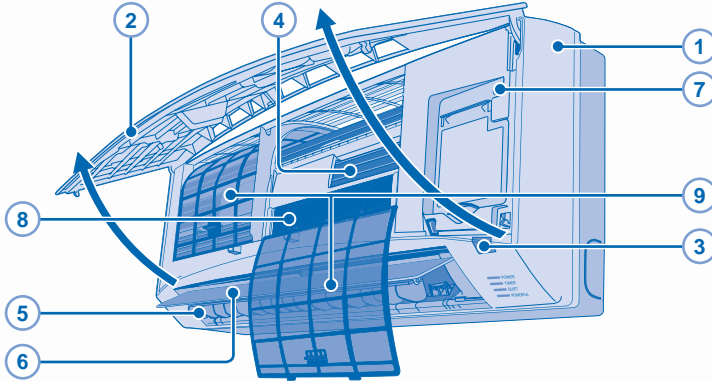

1 INDOOR UNIT

- Wipe the unit gently with a soft, dry cloth.

2 FRONT PANEL

- Remove Front Panel
- Raise and pull to remove the front panel.
 - Wash gently and dry.

Close Front Panel



- Press down both ends of the front panel to close it securely.

3 REMOTE CONTROL RECEIVER

4 ALUMINIUM FIN

5 HORIZONTAL AIRFLOW DIRECTION LOUVER

S9JKUW-1, S12JKUW-1

- Manually adjustable.



S18JKU-1, S22JKU-1

- Do not adjust by hand.

6 VERTICAL AIRFLOW DIRECTION LOUVER

- Do not adjust by hand.

7 AUTO OFF/ON BUTTON

- Use when remote control is misplaced or a malfunction occurs.

Action	Mode
Press once.	Auto
Press and hold until 1 beep is heard, then release.	Cooling
Press the button to turn off.	

8 AIR PURIFYING FILTER



Vacuum the air purifying filter.

- It is recommended to clean the filter every 6 months.
 - Replace the filter every 3 years or replace any damaged filter.
- Part no.: CZ-SA20P

9 AIR FILTERS

- Air filter cleaning is required every two weeks.
- Wash/rinse the filters gently with water to avoid damage to the filter surface.
- Dry the filters thoroughly under the shade, away from fire or direct sunlight.
- Replace any damaged filters.

REMOTE CONTROL

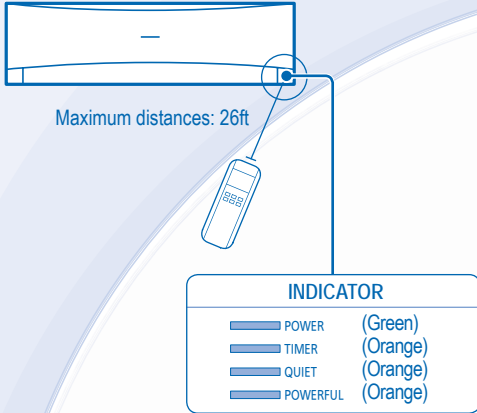

Press the remote control's button

1 TO TURN ON OR OFF THE UNIT

- Please be aware of the OFF indication on the remote control display to prevent the unit from starting/stopping improperly.

2 TO SET TEMPERATURE

- Selection range: 60°F ~ 86°F.
- Operating the unit within the recommended temperature could induce energy saving.
COOL mode : 78°F ~ 82°F.
DRY mode : 2°F ~ 4°F lower than room temperature.

3 TO SELECT OPERATION MODE

AUTO mode - For your convenience

- During operation mode selection the power indicator blinks.
- Unit selects operation mode every 30 minutes according to temperature setting, outdoor and room temperature (For Single Split System).
- Unit selects operation mode every 3 hours according to temperature setting, outdoor and room temperature (For Multi Split System).

COOL mode - To enjoy cool air

- Use curtains to screen off sunlight and outdoor heat to reduce power consumption during cool mode.

DRY mode - To dehumidify the environment

- Unit operates at low fan speed to give a gentle cooling operation.

4 TO SELECT FAN SPEED (5 OPTIONS)



- For AUTO, the indoor fan speed is automatically adjusted according to the operation mode.

5 TO ADJUST VERTICAL AIRFLOW DIRECTION (5 OPTIONS)



- Keeps the room ventilated.
- In COOL/DRY mode, if AUTO is set, the louver swing up/down automatically.

6 TO ADJUST AIRFLOW DIRECTION (5 OPTIONS)

(PAGE 7)



- Keeps the room ventilated.
- In COOL/DRY mode, if AUTO is set, the louver swing left/right and up/down automatically.

Remote Control display

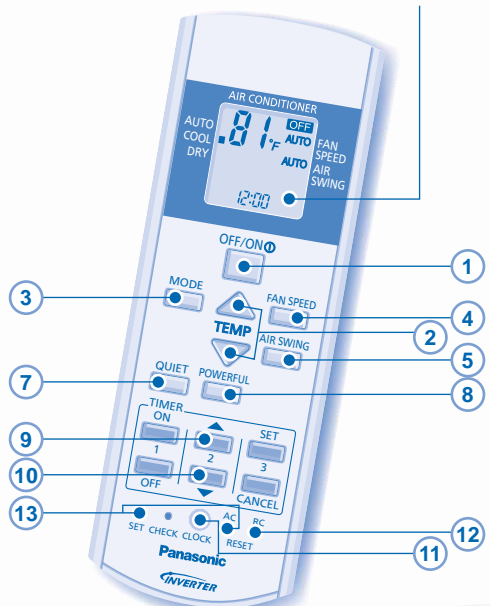

7 TO ENJOY QUIET OPERATION

- This operation reduces airflow noise.

8 TO REACH TEMPERATURE QUICKLY

- Single Split System: This operation stops automatically after 20 minutes.
- Multi Split System: Press the button again or turn OFF the unit to stop this operation.

9 Press and hold for 5 seconds to dim or restore the unit's indicator brightness.

10 Press and hold for approximately 10 seconds to show temperature setting in °C or °F.

11 Press and hold for approximately 5 seconds to show 12-hour (am/pm) or 24-hour time indication.

12 Press to restore the remote control's default setting.

13 Not used in normal operations.

NOTES

QUIET POWERFUL



- Can be activated in all modes and can be cancelled by pressing the respective button again.

QUIET POWERFUL







- Cannot be selected at the same time.

TO SET THE TIMER

- To turn ON or OFF the unit at a preset time.



- To cancel ON or OFF timer, press  or  then press .
- When ON Timer is set, the unit may start earlier (up to 15 minutes) before the actual set time in order to achieve the desired temperature on time.
- Timer operation is based on the clock set in the remote control and repeats daily once set. For clock setting, please refer to Remote Control Preparation at back cover.
- If timer is cancelled manually or due to power failure, you can restore the previous setting (once power is resumed) by pressing .

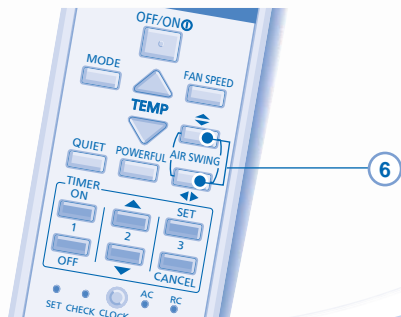

S18JKU-1, S22JKU-1

TROUBLESHOOTING

The following symptoms do not indicate malfunction.

SYMPTOM	CAUSE
Mist emerges from indoor unit.	▶ • Condensation effect due to cooling process.
Water flowing sound during operation.	▶ • Refrigerant flow inside the unit.
The room has a peculiar odour.	▶ • This may be due to damp smell emitted by the wall, carpet, furniture or clothing. ▶ • This helps to remove the surrounding odours.
Indoor fan stops occasionally during automatic fan speed setting.	▶ • The delay is a protection to the unit's compressor.
Operation is delayed a few minutes after restart.	▶ • Condensation or evaporation occurs on pipes.
Outdoor unit emits water/steam.	▶ • The timer setting repeats daily once set.
Timer indicator is always on.	▶ • This is a preliminary step in preparation for the operation when the ON timer has been set.
Power indicator blinks before the unit is switched on.	▶ • Changes of temperature cause the expansion/contraction of the unit.
Cracking sound during operation.	

Check the following before calling for servicing.

SYMPTOM	CHECK
Cooling operation is not working efficiently.	▶ • Set the temperature correctly. ▶ • Close all doors and windows. ▶ • Clean or replace the filters. ▶ • Clear any obstruction at the air inlet and air outlet vents.
Noisy during operation.	▶ • Check if the unit has been installed at an incline. ▶ • Close the front panel properly.
Remote control does not work. (Display is dim or transmission signal is weak.)	▶ • Insert the batteries correctly. ▶ • Replace weak batteries.
The unit does not work.	▶ • Check if the circuit breaker is tripped. ▶ • Check if timers have been set.
The unit does not receive the signal from the remote control.	▶ • Make sure the receiver not obstructed. ▶ • Certain fluorescent lights may interfere with signal transmitter. Please consult authorized dealer.

The unit stops and the timer indicator blinks.

Use remote control to retrieve error code.

- 1 Press for 5 seconds.
- 2 Press until you hear beep sound, then write down the error code.
- 3 Press for 5 seconds to quit checking.
- 4 Turn the unit off and reveal the error code to authorized dealer.

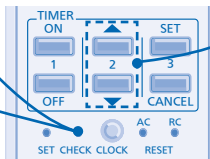

Note:

- For certain errors, you may restart the unit for limited operation with 4 beeps during operation starts.

INFORMATION

Information for Users on Collection and Disposal of Old Equipment and used Batteries



[Information on Disposal in other Countries outside the European Union]

These symbols are only valid in the European Union. If you wish to discard these items, please contact your local authorities or dealer and ask for the correct method of disposal.



Note for the battery symbol (bottom two symbol examples):



This symbol might be used in combination with a chemical symbol. In this case it complies with the requirement set by the Directive for the chemical involved.

Pb

Contact your country hazardous waste disposal hotline.

FOR SEASONAL INSPECTION AFTER EXTENDED NON-USE

- Checking of remote control batteries.
- No obstruction at air inlet and air outlet vents.
- After 15 minutes of operation, it is normal to have the following temperature difference between air inlet and air outlet vents:
Cooling: $\geq 46.4^{\circ}\text{F}$

FOR EXTENDED NON-USE

- Turn off the power supply.
- Remove the remote control batteries.

SERVICEABLE CRITERIAS

TURN OFF POWER SUPPLY then please consult authorized dealer under the following conditions:

- Abnormal noise during operation.
- Water/foreign particles have entered the remote control.
- Water leaks from Indoor unit.
- Circuit breaker switches off frequently.
- Power cord becomes unnaturally warm.
- Switches or buttons are not functioning properly.

MEMO

A series of horizontal dotted lines for writing, spanning the width of the page and following a curved path on the left side.

MEMO

A series of horizontal dotted lines for writing, spanning the width of the page.

QUICK GUIDE

Remote Control Preparation

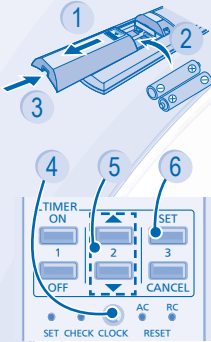

- 1 Pull out
- 2 Insert AAA or R03 batteries (can be used ~ 1 year)
- 3 Close the cover
- 4 Press CLOCK
- 5 Set time
- 6 Confirm

1

MODE



Select the desired mode.

2

OFF/ON

Start/stop the operation.

3

TEMP

Select the desired temperature.

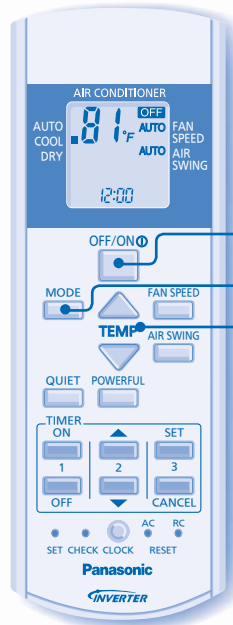

S9JKUW-1, S12JKUW-1

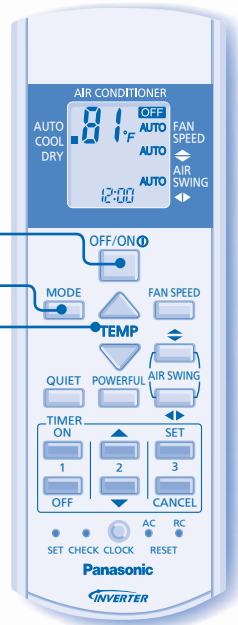

S18JKU-1, S22JKU-1

Panasonic Corporation

Website: <http://panasonic.net/>

For enquiries, please call 1-800-851-1235