

Panasonic®

Basic Owner's Manual

Digital Camera/
Lens Kit/Double Zoom Lens Kit

Model No. **DMC-G7K/DMC-G7H**
DMC-G7W



LUMIX

Please read these instructions carefully before using this product, and save this manual for future use.

More detailed instructions on the operation of this camera are contained in “Owner’s Manual for advanced features (PDF format)” in the supplied DVD.



Register online at <http://shop.panasonic.com/support> (U.S. customers only)

If you have any questions, visit:
USA : <http://shop.panasonic.com/support>
Canada : www.panasonic.ca/english/support



Dear Customer,

Thank you for choosing Panasonic!

You have purchased one of the most sophisticated and reliable products on the market today. Used properly, we're sure it will bring you and your family years of enjoyment. Please take time to fill in the information below. The serial number is on the tag located on the underside of your camera. Be sure to **retain this manual** as your convenient camera information source.

Date of Purchase	Dealer Phone No.
Dealer Purchased From	Model No.
Dealer Address	Serial No.

Please note that the actual controls and components, menu items, etc. of your Digital Camera may look somewhat different from those shown in the illustrations in this Owner's Manual.

Carefully observe copyright laws.

- Recording of pre-recorded tapes or discs or other published or broadcast material for purposes other than your own private use may infringe copyright laws. Even for the purpose of private use, recording of certain material may be restricted.

For the U.S.A. and Canada only



A lithium ion battery that is recyclable powers the product you have purchased. Please call 1-800-8-BATTERY for information on how to recycle this battery.

Information for Your Safety

WARNING:

To reduce the risk of fire, electric shock or product damage,

- **Do not expose this unit to rain, moisture, dripping or splashing.**
- **Use only the recommended accessories.**
- **Do not remove covers.**
- **Do not repair this unit by yourself. Refer servicing to qualified service personnel.**

The socket outlet shall be installed near the equipment and shall be easily accessible.

■ Product identification marking

Product	Location
Digital Camera	Bottom
Battery charger	Bottom

THE FOLLOWING APPLIES ONLY IN THE U.S.A.

FCC Note:

This equipment has been tested and found to comply with the limits for a Class B digital device, pursuant to Part 15 of the FCC Rules. These limits are designed to provide reasonable protection against harmful interference in a residential installation. This equipment generates, uses, and can radiate radio frequency energy and, if not installed and used in accordance with the instructions, may cause harmful interference to radio communications. However, there is no guarantee that interference will not occur in a particular installation. If this equipment does cause harmful interference to radio or television reception, which can be determined by turning the equipment off and on, the user is encouraged to try to correct the interference by one or more of the following measures:

- Reorient or relocate the receiving antenna.
- Increase the separation between the equipment and receiver.
- Connect the equipment into an outlet on a circuit different from that to which the receiver is connected.
- Consult the dealer or an experienced radio/TV technician for help.

FCC Caution:

- Any unauthorized changes or modifications to this equipment would void the user's authority to operate this device.
- To assure continued compliance, follow the attached installation instructions and use only shielded interface cables with ferrite core when connecting to computer or peripheral devices.

This device complies with Part 15 of the FCC Rules. Operation is subject to the following two conditions: (1) This device may not cause harmful interference, and (2) this device must accept any interference received, including interference that may cause undesired operation.

Supplier's Declaration of Conformity

Trade Name: Panasonic
Model No.: DMC-G7
Responsible Party: Panasonic Corporation of North America
Two Riverfront Plaza, Newark, NJ 07102-5490
Support Contact: <http://shop.panasonic.com/support>



THE FOLLOWING APPLIES ONLY IN THE U.S.A.

Certification and Compliance

See Camera for the certification and compliance mark specific to that device.

- 1 Select **[Wi-Fi]** in the **[Setup]** menu.
- 2 Select **[Wi-Fi Setup]** in the **[Wi-Fi]** menu.
- 3 Press **▲/▼** to select **[Approved Regulations]**, and then press **[MENU/SET]**.

Contains FCC ID: VPYLBXN604

This transmitter must not be co-located or operated in conjunction with any other antenna or transmitter.

This equipment complies with FCC radiation exposure limits set forth for an uncontrolled environment and meets the FCC radio frequency (RF) Exposure Guidelines in Supplement C to OET65.

This equipment has very low levels of RF energy that are deemed to comply without testing of specific absorption ratio (SAR).

THE FOLLOWING APPLIES ONLY IN CANADA.

CAN ICES-3(B)/NMB-3(B)

This device complies with RSS-210 of the IC Rules.

Operation is subject to the following two conditions:

- (1) This device may not cause harmful interference,
- (2) This device must accept any interference received, including interference that may cause undesired operation of the device.

This equipment complies with IC radiation exposure limits set forth for an uncontrolled environment and meets RSS-102 of the IC radio frequency (RF) Exposure rules.

This equipment has very low levels of RF energy that are deemed to comply without testing of specific absorption ratio (SAR).

Contains IC : 772C-LBXN604

■ About the battery pack

CAUTION

Battery pack (Lithium ion battery pack)

- Use the specified unit to recharge the battery pack.
- Do not use the battery pack with equipment other than the specified unit.
- Do not get dirt, sand, liquids, or other foreign matter on the terminals.
- Do not touch the plug terminals (+ and –) with metal objects.
- Do not disassemble, remodel, heat or throw into fire.

If any electrolyte should come into contact with your hands or clothes, wash it off thoroughly with water. If any electrolyte should come into contact with your eyes, never rub the eyes. Rinse eyes thoroughly with water, and then consult a doctor.

CAUTION

- Danger of explosion if battery is incorrectly replaced. Replace only with the type recommended by the manufacturer.
 - When disposing of the batteries, please contact your local authorities or dealer and ask for the correct method of disposal.
- Do not heat or expose to flame.
 - Do not leave the battery(ies) in a car exposed to direct sunlight for a long period of time with doors and windows closed.

Warning

Risk of fire, explosion and burns. Do not disassemble, heat above 60 °C (140 °F) or incinerate.

■ About the battery charger

CAUTION!

To reduce the risk of fire, electric shock or product damage,

- **Do not install or place this unit in a bookcase, built-in cabinet or in another confined space. Ensure this unit is well ventilated.**

Battery charger

This battery charger operates on AC between 110 V and 240 V.

But

- In the U.S.A. and Canada, the battery charger must be connected to a 120 V AC power supply only.
- When connecting to an AC supply outside of the U.S.A. or Canada, use a plug adaptor to suit the AC outlet configuration.

Cautions for Use

- Do not use any other USB connection cables except the supplied one or a genuine Panasonic USB connection cable (DMW-USBC1: optional).
- Use a "High Speed HDMI micro cable" with the HDMI logo.
Cables that do not comply with the HDMI standards will not work.
"High Speed HDMI micro cable" (Type D–Type A plug, up to 2 m (6.6 feet) long)
- Always use a genuine Panasonic AV cable (DMW-AVC1: optional).
- Always use a genuine Panasonic remote shutter (DMW-RSL1: optional).

Keep this unit as far away as possible from electromagnetic equipment (such as microwave ovens, TVs, video games etc.).

- If you use this unit on top of or near a TV, the pictures and/or sound on this unit may be disrupted by electromagnetic wave radiation.
- Do not use this unit near cell phones because doing so may result in noise adversely affecting the pictures and/or sound.
- Recorded data may be damaged, or pictures may be distorted, by strong magnetic fields created by speakers or large motors.
- Electromagnetic wave radiation may adversely affect this unit, disturbing the pictures and/or sound.
- If this unit is adversely affected by electromagnetic equipment and stops functioning properly, turn this unit off and remove the battery or disconnect AC adaptor (DMW-AC10PP: optional). Then reinsert the battery or reconnect AC adaptor and turn this unit on.

Do not use this unit near radio transmitters or high-voltage lines.

- If you record near radio transmitters or high-voltage lines, the recorded pictures and/or sound may be adversely affected.

• Before cleaning the camera, remove the battery or the DC coupler (DMW-DCC8: optional), or disconnect the power plug from the outlet.

- **Do not press the monitor with excessive force.**
- **Do not press the lens with excessive force.**
- **Do not spray the camera with insecticides or volatile chemicals.**
- **Do not keep rubber or plastic products in contact with the camera for a long period of time.**
- **Do not use solvents such as benzine, thinner, alcohol, kitchen detergents, etc., to clean the camera, since it may deteriorate the external case or the coating may peel off.**
- **Do not leave the camera with the lens facing the sun, as rays of light from the sun may cause it to malfunction.**
- **Always use the supplied cords and cables.**
- **Do not extend the cords or the cables.**
- **During access (image writing, reading and deleting, formatting etc.), do not turn this unit off, remove the battery, card or disconnect the AC adaptor (DMW-AC10PP: optional). Furthermore, do not subject the camera to vibration, impact or static electricity.**
- The data on the card may be damaged or lost due to electromagnetic waves, static electricity or breakdown of the camera or the card. We recommend storing important data on a PC etc.
- Do not format the card on your PC or other equipment. Format it on the camera only to ensure proper operation.

• The battery is not charged when the camera is shipped. Charge the battery before use.

- **The battery is a rechargeable lithium ion battery. If the temperature is too high or too low, the operating time of the battery will become shorter.**
 - The battery becomes warm after using and during and after charging. The camera also becomes warm during use. This is not a malfunction.
 - **Do not leave any metal items (such as clips) near the contact areas of the power plug or near the batteries.**
 - Store the battery in a cool and dry place with a relatively stable temperature: [Recommended temperature: 15 °C to 25 °C (59 °F to 77 °F), Recommended humidity: 40%RH to 60%RH]
 - **Do not store the battery for a long time while fully charged.** When storing the battery for a long period of time, we recommend charging it once a year. Remove the battery from the camera and store it again after it has completely discharged.
-

Contents

Information for Your Safety	2
• Cautions for Use.....	5

Preparation/Basic

Care of the camera.....	9
Standard Accessories	10
Names and Functions of Components	11
Preparation	13
• Attaching the Shoulder Strap.....	13
• Charging the Battery	14
• Inserting/Removing the Battery	15
• Inserting/Removing the Card (Optional)	15
• Formatting the card (initialization)	16
• Attaching/Removing the Lens	17
• Opening the Monitor/ Adjusting the Monitor	17
• Setting Date/Time (Clock Set).....	18
• Diopter adjustment	18
Basic Operations.....	19
• Shutter button (Taking pictures)	19
• Motion picture button (Recording motion pictures)	19
• Mode dial (Selecting a Recording Mode).....	20
• Cursor buttons/ [MENU/SET] button.....	20
• Front Dial/Rear Dial	21
• [LVF] button (Switching the Monitor/Viewfinder)	22
• Touch screen (Touch operations)	22
Setting menu items	23
Calling frequently-used menus instantly (Quick Menu).....	24
Assigning frequently used functions to the buttons (function buttons)	24

Recording

Taking Pictures using the Automatic Function (Intelligent Auto Mode).....	25
• Recording night scenes ([iHandheld Night Shot])	25
• Combining pictures into a single picture with rich gradation ([iHDR]).....	26
• Taking a picture with a blurred background (Defocus Control).....	26
• Recording images by changing the brightness or color tone.....	26
Recording motion pictures with manually set aperture value/shutter speed (Creative Video Mode).....	27
Setting the Picture Quality and Size	28
• Setting the aspect ratio of pictures	28
• Setting the number of pixels	28
• Setting the compression rate of pictures ([Quality])	29
Adjusting Focus Manually	30
Select a Drive Mode.....	31
Recording 4K Photos	32
• Selecting pictures from 4K burst file and saving	33
Recording Motion Picture.....	34
• Recording motion pictures in 4K....	37

Playback

Playing Back Pictures	38
Playing Back Motion Pictures	38
Deleting Pictures	39
Using the [Playback] Menu	40
• [RAW Processing]	40

Wi-Fi

What you can do with the Wi-Fi® function	42
Controlling with a Smartphone/ Tablet	42
• Installing the smartphone/tablet app "Image App"	42
Connecting to a smartphone/ tablet	43
• Taking images via a smartphone/ tablet (remote recording)	44
• Playing back images in the camera	44
• Saving images stored in the camera	45
• Sending images in the camera to an SNS	45
• Adding location information to images stored in the camera from a smartphone/tablet	45
• Combining motion pictures recorded with Snap Movie according to your preference on a smartphone/tablet	46

Others

About the supplied software	47
Monitor Display/ Viewfinder Display	48
Menu list	52
Troubleshooting	54
Specifications	60
Digital Camera Accessory System ...	67
Reading the Owner's Manual (PDF format)	68
Limited Warranty (ONLY FOR U.S.A.)	69
Limited Warranty (ONLY FOR CANADA)	73

Care of the camera

Do not subject to strong vibration, shock, or pressure.

- The lens, monitor, or external case may be damaged if used in the following conditions. It may also malfunction or image may not be recorded if you:
 - Drop or hit the camera.
 - Press hard on the lens or the monitor.

This camera is not dust/drip/water proof.

Avoid using the camera in places with a lot of dust, water, sand, etc.

- Liquid, sand and other foreign material may get into the space around the lens, buttons, etc. Be particularly careful since it may not just cause malfunctions, but it may also become irreparable.
 - Places with a lot of sand or dust.
 - Places where water can come into contact with this unit, such as when using it on a rainy day or at the beach.

Do not place your hands inside the mount of the digital camera body. Since the sensor unit is a precision apparatus, it may cause a malfunction or damage.

■ About Condensation (When the lens, the viewfinder or monitor is fogged up)

- Condensation occurs when the ambient temperature or humidity changes. Be careful of condensation since it causes lens, viewfinder and monitor stains, fungus and camera malfunction.
- If condensation occurs, turn the camera off and leave it for about 2 hours. The fog will disappear naturally when the temperature of the camera becomes close to the ambient temperature.

About the firmware of your interchangeable lens

For smoother recording, we recommend updating the firmware of the interchangeable lens to the latest version.

- **To view the latest information on the firmware or to download the firmware, visit the support site below:**

<http://panasonic.jp/support/global/cs/dsc/>

(This Site is English only.)

- To check the firmware version of the interchangeable lens, attach it to the camera body and select [Version Disp.] in the [Setup] menu.









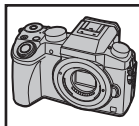













Standard Accessories

Check that all the accessories are supplied before using the camera.
Product numbers correct as of May 2015. These may be subject to change.

Digital Camera Body

(This is referred to as **camera body** in this owner's manual.)



	DMC-G7K	DMC-G7W		DMC-G7H
1 Interchangeable Lens* ¹	 H-FS1442A	 H-FS1442A	 H-FS45150	 H-FS14140
2 Lens Hood (Indicated as battery pack or battery in the text) Charge the battery before use.	 VYC1113	 VYC1113	 VYC1090	 VYC1119
3 Battery Charger (Indicated as battery charger or charger in the text)	 VYF3510	 VYF3510	 VYF3201	 VYF3514
4 USB Connection Cable	 VFC4605	 VFC4605	 VFC4605	 VFC4605
5 DVD • Software: Use it to install the software to your PC. • Owner's Manual for advanced features	 VKF4971	 DMW-BLC12PP		
10 Shoulder Strap	 DE-A79B	 K1HY08Y0031		
11 Hot shoe cover* ³	 SKF0106K	 SFM0092	 VFC5167	

*1 This is referred to as **lens** in this owner's manual.

*2 This is attached to the interchangeable lens at the time of purchase.

*3 This is attached to the camera body at the time of purchase.

• SD Memory Card, SDHC Memory Card and SDXC Memory Card are indicated as **card** in the text.

• **The card is optional.**

• Description in this owner's manual is based on the interchangeable lens (H-FS1442A).

(For U.S.A. only)

• If accessories are lost, customers can visit us at <http://shop.panasonic.com/support> for further information about obtaining replacement parts.

(For Canada only)

• If any accessories are lost, customers in Canada should visit our support page at www.panasonic.ca/english/support for further information about obtaining replacement parts.

Names and Functions of Components

■ Camera body

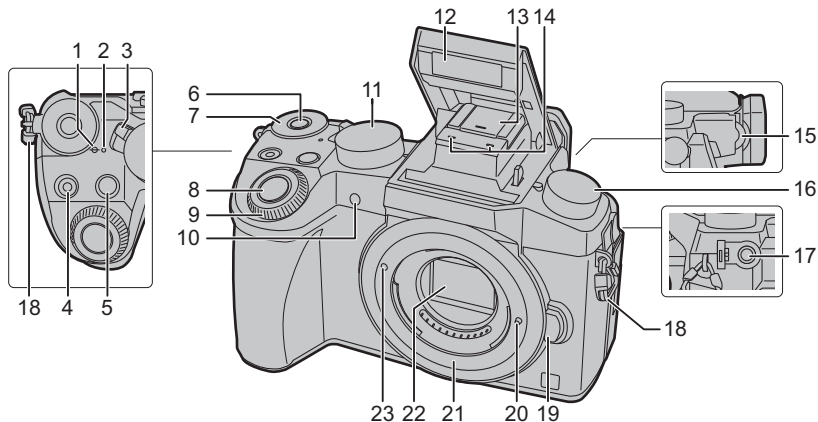

1 Focus distance reference mark	
Status indicator (P18)/ Wi-Fi® connection lamp	
2 • The lamp lights green when the camera is turned on, and lights blue when it is connected to Wi-Fi.	
3 Camera ON/OFF switch (P18)	
4 Motion picture button (P34)	
5 [] (Exposure Compensation) button/ [Fn1] button (P24)	
6 Function button (Fn11) (P24)	
7 Rear dial (P21)	
8 Shutter button (P19)	
9 Front dial (P21)	
10 Self-timer indicator/ AF Assist Lamp	
Mode dial (P20)	
11 • Rotate the mode dial to switch the Recording Mode.	
12 Flash	
Hot shoe (Hot shoe cover)	
13 • Keep the Hot Shoe Cover out of reach of children to prevent swallowing.	
	14 Stereo microphone • Be careful not to cover the microphone with your finger. Doing so may make sound difficult to record.
	15 Diopter adjustment dial (P18)
	Drive mode dial Single (P31): <input type="checkbox"/> Burst:
	16 4K Photo (P32): Auto Bracket: Self-timer: Time Lapse/Animation:
	[MIC] socket (P67) 17 • An external microphone (optional) can record higher quality audio than the built-in microphone.
	18 Shoulder strap eyelet (P13)
	19 Lens release button (P17)
	20 Lens lock pin
	21 Mount
	22 Sensor
	23 Lens fitting mark (P17)

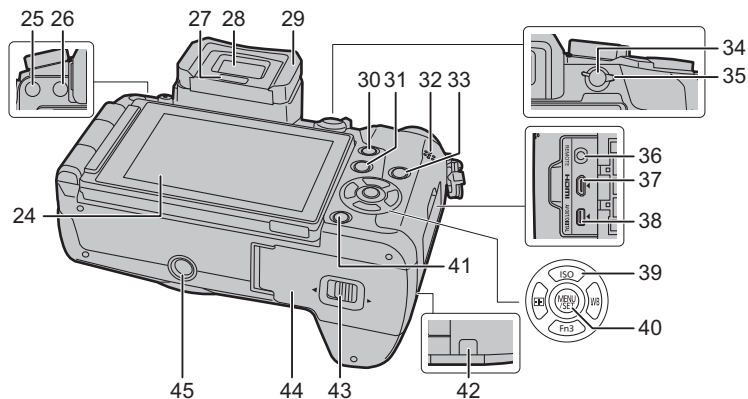

24	Touch screen (P22)/monitor (P48)	39	Cursor buttons (P20) ▲/[ISO] (ISO sensitivity) ▶/[WB] (White Balance) ◀/[AF] (Auto Focus Mode) ▼/[Fn3] (P24)
25	[LVF] button (P22)/[Fn5] button (P24)	40	[MENU/SET] button (P20, 23)
26	Flash open button • The flash opens, and recording with the flash becomes possible.	41	[/] (Delete/Cancel) button (P39)/ [Fn4] button (P24)
27	Eye sensor (P22)	42	DC coupler cover (P67) • When using an AC adaptor, ensure that the Panasonic DC coupler (DMW-DCC8: optional) and AC adaptor (DMW-AC10PP: optional) are used. • Always use a genuine Panasonic AC adaptor (DMW-AC10PP: optional). • When using an AC adaptor, use the AC cable lead supplied with the AC adaptor.
28	Viewfinder (P22)	43	Release lever (P15)
29	Eye Cup	44	Card/Battery door (P15)
30	[Q.MENU] button (P24)/[Fn2] button (P24)	45	Tripod mount • It may not be possible to attach and securely fasten a tripod with a screw length of 5.5 mm (0.22 inch) or more to the camera. Doing so may also damage the camera.
31	[] (Playback) button (P38)		
32	Speaker (P53) • Be careful not to cover the speaker with your finger. Doing so may make sound difficult to hear.		
33	[DISP.] button • Each time this is pressed, the display on the monitor is switched.		
34	[AF/AE LOCK] button		
35	Focus mode lever (P30)		
36	[REMOTE] socket		
37	[HDMI] socket		
38	[AV OUT/DIGITAL] socket		

■ Lens

H-FS1442A

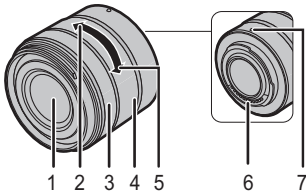

H-FS45150

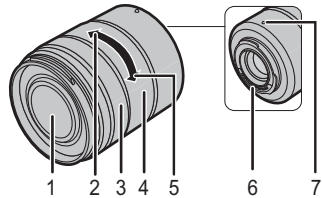

H-FS14140

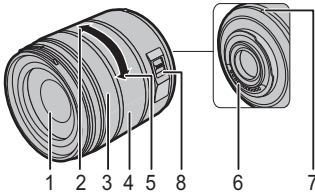

- 1 Lens surface
- 2 Tele
- 3 Focus ring (P30)
- 4 Zoom ring
- 5 Wide
- 6 Contact point
- 7 Lens fitting mark (P17)
- 8 [O.I.S.] switch

Preparation

- Check that the camera is turned off.

Attaching the Shoulder Strap

- We recommend attaching the shoulder strap when using the camera to prevent it from dropping.

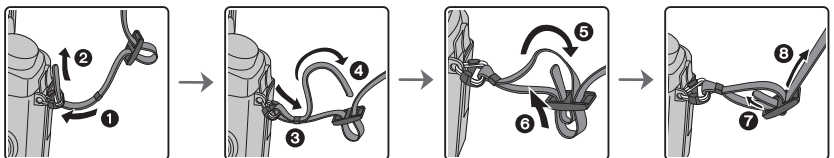

- Perform steps ① to ⑧ and then attach the other side of the shoulder strap.
- Use the shoulder strap around your shoulder.
 - Do not wrap the strap around your neck.
 - It may result in injury or accident.
- Do not leave the shoulder strap where an infant can reach it.
 - It may result in an accident by mistakenly wrapping around the neck.

Charging the Battery

The battery that can be used with this unit is **DMW-BLC12PP**.

- 1 Attach the battery paying attention to the direction of the battery.
- 2 Connect the charger to the electrical outlet.
 - The [CHARGE] indicator (A) lights up and charging begins.

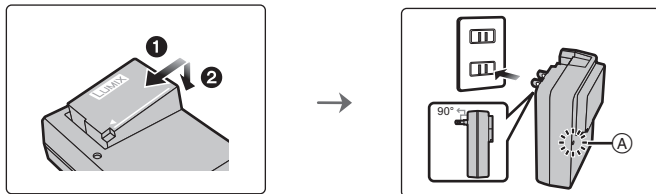

■ About the [CHARGE] indicator

On: Charging.

Off: Charging has completed.
(Disconnect the charger from the electrical socket and detach the battery after charging is completed.)

• When the [CHARGE] indicator flashes

- The battery temperature is too high or too low. It is recommended to charge the battery again in an ambient temperature of between 10 °C and 30 °C (50 °F and 86 °F).
- The terminals of the charger or the battery are dirty. In this case, wipe them with a dry cloth.

■ Charging time

Charging time

Approx. 140 min

- The indicated charging time is for when the battery has been discharged completely. The charging time may vary depending on how the battery has been used.
- The charging time for the battery in hot/cold environments or a battery that has not been used for a long time may be longer than normal.

Inserting/Removing the Battery

- Always use genuine Panasonic batteries (DMW-BLC12PP).
- If you use other batteries, we cannot guarantee the quality of this product.

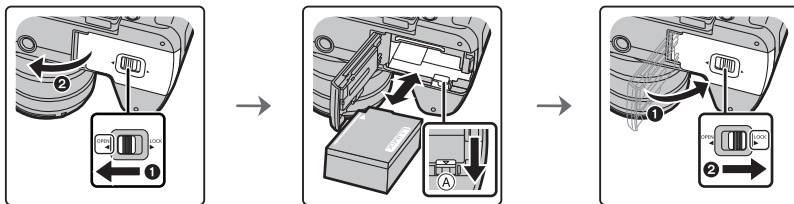

- Being careful about the battery orientation, insert all the way until you hear a locking sound and then check that it is locked by lever (A).
Pull the lever (A) in the direction of the arrow to remove the battery.

Inserting/Removing the Card (Optional)

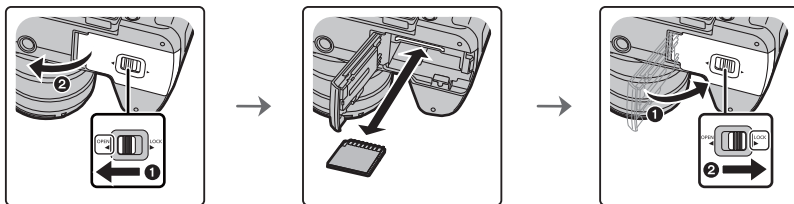

- Push it securely all the way until you hear a “click” while being careful about the direction in which you insert it.
To remove the card, push the card until it clicks, then pull the card out upright.

■ About cards that can be used with this unit



SD Memory Card (512 MB to 2 GB)	<ul style="list-style-type: none"> • SDHC Memory Cards and SDXC Memory Cards can be used only with their compatible devices. • Check that the PC and other equipment are compatible when using the SDXC Memory Cards.
SDHC Memory Card (4 GB to 32 GB)	<p>http://panasonic.net/avc/sdcard/information/SDXC.html</p> <ul style="list-style-type: none"> • This unit is compatible with UHS-I/UHS-II* UHS Speed Class 3 standard SDHC/SDXC memory cards.
SDXC Memory Card (48 GB to 128 GB)	<ul style="list-style-type: none"> • Operation of the cards on the left has been confirmed with Panasonic's cards.

- * UHS-I/UHS-II is a high speed interface standard for SD memory cards. UHS-II supports a theoretical transfer rate approximately three times faster than that of UHS-I.

■ About motion picture/4K photo recording and speed class ratings

According to the [Rec Format] (P36) and [Rec Quality] (P36) of a motion picture, the required card differs. To record 4K photos, you need a card with a speed class rating that supports 4K photo recording. Use a card that meets the following ratings of the SD Speed Class or UHS Speed Class.

- SD Speed Class and UHS Speed Class are the speed standards regarding continuous writing. To check the class, see the labelled side, etc. of the card.

[Rec Format]	[Rec Quality]	Speed class	Label example
[AVCHD]	All	Class 4 or higher	CLASS  
[MP4]	FHD/HD/VGA		
[MP4]	4K	UHS Speed Class 3	

When recording 4K photos	UHS Speed Class 3	
--------------------------	-------------------	---

- Please confirm the latest information on the following website.

<http://panasonic.jp/support/global/cs/dsc/>

(This Site is English only.)

- Keep the Memory Card out of reach of children to prevent swallowing.

Formatting the card (initialization)

Format the card before recording a picture with this unit.

Since data cannot be recovered after formatting, make sure to back up necessary data in advance.

Select the menu. (P23)

MENU →  **[Setup]** → **[Format]**

- Confirmation screen is displayed. It is executed when [Yes] is selected.

Attaching/Removing the Lens

- Change lenses where there is not a lot of dirt or dust.

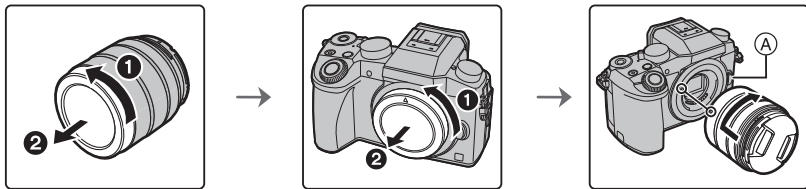

- Do not press the lens release button (A) when you attach a lens.

■ Detaching the lens

- 1 Attach the lens cap.
- 2 While pressing on the lens release button (B), rotate the lens toward the arrow until it stops and then remove.

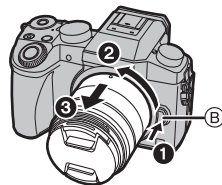

Opening the Monitor/Adjusting the Monitor

At the time when this camera is purchased, the monitor is stowed in the camera body. Bring out the monitor as shown below.

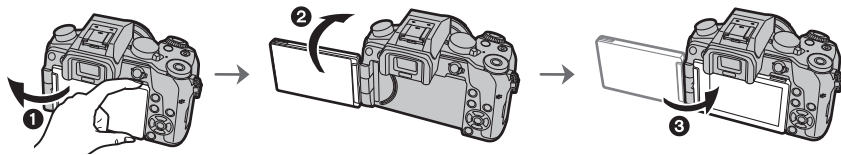

- 1 Open the monitor. (Maximum 180°)
 - 2 It can be rotated 180° forward.
 - 3 Return the monitor to its original position.
- Only rotate the monitor after opening it wide enough, and be careful not to use excessive force as it may be damaged.

- When not using the monitor it is recommended that you close it with the screen facing inward to prevent dirt and scratches.

Setting Date/Time (Clock Set)

- The clock is not set when the camera is shipped.

- 1 Turn the camera on.
 - When the camera is turned on, the status indicator ❶ lights up green.
- 2 Press [MENU/SET].
- 3 Press ▲/▼ to select the language, and press [MENU/SET].
- 4 Press [MENU/SET].
- 5 Press ◀/▶ to select the items (year, month, day, hour, minute), and press ▲/▼ to set.

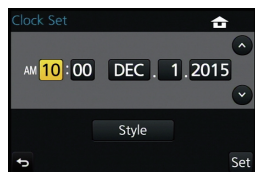
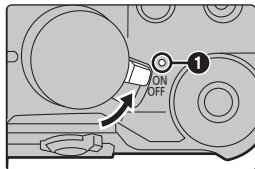

- 6 Press [MENU/SET] to set.
- 7 When [The clock setting has been completed.] is displayed, press [MENU/SET].
- 8 When [Please set the home area] is displayed, press [MENU/SET].
- 9 Press ◀/▶ to select the home area, and then press [MENU/SET].

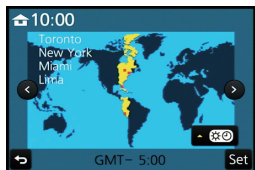

Diopter adjustment

Adjust the diopter to suit your vision so that you can see the characters displayed in the viewfinder clearly.

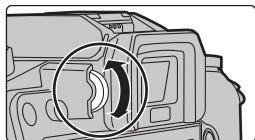

Basic Operations

Shutter button (Taking pictures)

The shutter button works in two steps. To take a picture, press it.

Press the shutter button halfway to focus.

- Ⓐ Aperture value
- Ⓑ Shutter speed
- Ⓒ Focus indication

- Aperture value and shutter speed are displayed.
(It will flash in red if the correct exposure is not achieved, except when set to flash.)
- Once the subject is in focus, the focus indication is displayed.
(When the subject is not in focus, the indication flashes)

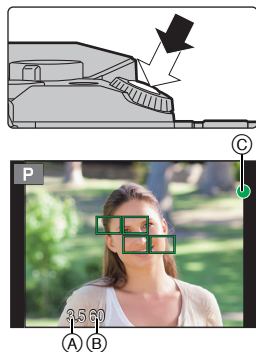

Press the shutter button fully (push it in further), and take the picture.

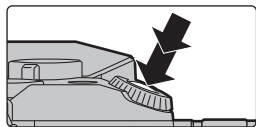

- When the image is correctly focused, the picture will be taken, since the [Focus/Release Priority] is set initially to [FOCUS].
- The focus range is different depending on the lens used.
- Even during menu operation or image playback, if you press the shutter button halfway, you can instantly set the camera ready for recording.

Motion picture button (Recording motion pictures)

Press the motion picture button to start and stop recording a motion picture.

Start recording by pressing the motion picture button.

- Release the motion picture button right after you press it.

Stop the recording by pressing the motion picture button again.

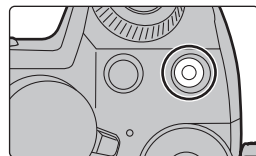





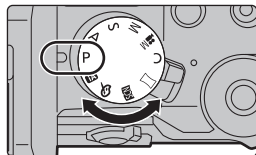

Mode dial (Selecting a Recording Mode)

Select the mode by rotating the mode dial.

- Rotate the mode dial slowly to select the desired mode.



	Intelligent Auto Mode (P25) The subjects are recorded using settings automatically selected by the camera.
	Intelligent Auto Plus Mode (P25) Allows you to adjust the brightness and color hue when in Intelligent Auto Mode.
P	Program AE Mode Records at the aperture value and shutter speed set by the camera.
A	Aperture-Priority AE Mode The shutter speed is automatically determined by the aperture value you set.
S	Shutter-Priority AE Mode The aperture value is automatically determined by the shutter speed you set.
M	Manual Exposure Mode The exposure is adjusted by the aperture value and the shutter speed which are manually adjusted.
	Creative Video Mode (P27) Records motion pictures with a manually set aperture value and shutter speed. * You cannot take still pictures.
C	Custom Mode Use this mode to take pictures with previously registered settings.
	Panorama Shot Mode This mode allows you to take panorama pictures.
	Scene Guide Mode This mode allows you to take pictures that match the scene being recorded.
	Creative Control Mode Record while checking the image effect.

Cursor buttons/[MENU/SET] button

Pressing the cursor button:

Selection of items or setting of values etc., is performed.

Pressing [MENU/SET]:

Confirmation of setting contents, etc., is performed.

- This owner's manual explains the up, down, left, and right of the cursor button as ▲/▼/◀/▶.

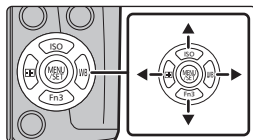

Front Dial/Rear Dial

Rotating:

Selection of items or setting of values is performed during the various settings.

- This owner's manual describe operations of the front dial/rear dial as follows:

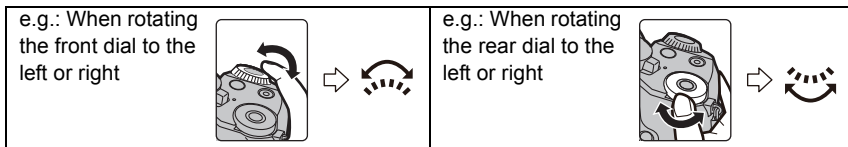

Allows you to set the aperture, shutter speed, and other settings when in **P / A / S / M** modes.

Mode dial	Front dial	Rear Dial
P	Program Shift	Program Shift
A	Aperture value	Aperture value
S	Shutter speed	Shutter speed
M	Aperture value	Shutter speed

- In [Dial Set.] in the [Custom] menu, you can change the operation methods of the rear dial and front dial.

Temporarily changing the items assigned to the front/rear dials ([Dial Operation Switch])

You can temporarily change the items assigned to the front/rear dials using the function button to which [Dial Operation Switch] is assigned.

[Dial Operation Switch] is assigned to [Fn11] at the time of purchase. (P24)

- You can set the items to be assigned temporarily to the front/rear dials in [Dial Operation Switch Setup] in [Dial Set.] in the [Custom] menu.

1 Press [Fn11].

- A guide will be displayed showing the items temporarily assigned to the front/rear dials.

2 Rotate the front/rear dials while the guide is displayed.

- The setting of the item assigned to the dial you have rotated will change. To change the setting of the item assigned to the other dial, rotate it.

3 Press [MENU/SET] and set.

- When the recording screen is displayed, the original assignment settings for the dials are restored.

- Items that are temporarily assigned to the front/rear dials can be used only while the guide (step 1) or setting screen (step 2) is displayed. If you display a menu or turn off the camera while making adjustments, the original assignment settings will be restored.



[LVF] button (Switching the Monitor/Viewfinder)

Press [LVF] to switch between the Monitor and Viewfinder.

- Ⓐ [LVF] button
- Ⓑ Eye sensor

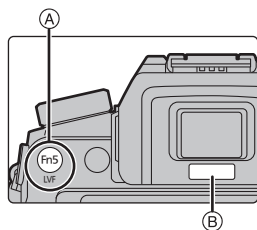

Press [LVF].

- The monitor/viewfinder will switch as follows:

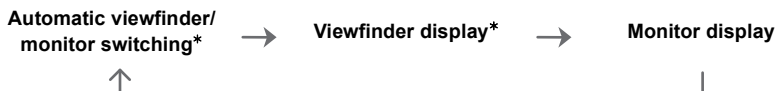

- * If [Eye Sensor AF] in the [Custom] menu is set to [ON], the camera automatically adjusts the focus as the eye sensor is activated.

■ Notes on automatic viewfinder/monitor switching

Automatic viewfinder/monitor switching enables the eye sensor to switch the display to the viewfinder automatically when you bring your eye or an object near it.

Touch screen (Touch operations)

Touch screen of this unit is capacitive. Touch the panel directly with your bare finger.

■ Touch

To touch and release the touch screen.

- When selecting features using the touch screen, be sure to touch the center of the desired icon.



■ Drag

A movement without releasing the touch screen.

This can also be used to move to the next image during playback, etc.

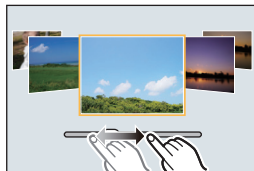

■ Pinch (enlarge/reduce)

Pinch the touch screen apart (enlarge) or together (reduce) with two fingers.



Setting menu items

1 Press [MENU/SET].

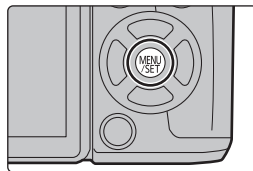

2 Press ▲/▼ of the cursor button to select the menu item and press [MENU/SET].

3 Press ▲/▼ of the cursor button to select the setting and press [MENU/SET].

- Depending on the menu item, its setting may not appear or it may be displayed in a different way.



■ Close the menu

Press [⏪/⏩] or press the shutter button halfway.

■ Switching to other menus

e.g.: Switching to the [Setup] menu from [Rec] menu.

1 Press ◀.

2 Press ▲/▼ to select a menu selector icon, such as [⚙].

- You can also select the menu toggle icons by rotating the front dial.

3 Press [MENU/SET].

- Select a menu item next and set it.



Calling frequently-used menus instantly

(Quick Menu)

By using the Quick Menu, some of the menu settings can be easily found.

- The features that can be adjusted using Quick Menu are determined by the mode or a display style the camera is in.

- 1 Press [Q.MENU] to display the Quick Menu.
- 2 Rotate the front dial to select the menu item.

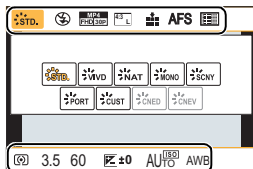

- 3 Rotate the rear dial to select the setting.
- 4 Press [Q.MENU] to exit the menu once the setting is complete.

Assigning frequently used functions to the buttons (function buttons)

You can assign recording functions, etc. to specific buttons and icons.

- 1 Select the menu. (P23)

MENU → **fC [Custom]** → **[Fn Button Set]**

- 2 Press ▲/▼ to select [Setting in REC mode] or [Setting in PLAY mode] and then press [MENU/SET].
- 3 Press ▲/▼ to select the function button you want to assign a function to and then press [MENU/SET].
- 4 Press ▲/▼ to select the function you want to assign and then press [MENU/SET].

- Some functions cannot be assigned depending on the function button.

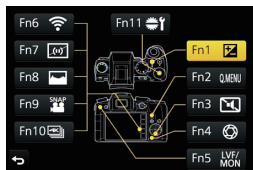

Taking Pictures using the Automatic Function

(Intelligent Auto Mode)

Recording Mode:  

In this mode, the camera makes the optimal settings for the subject and scene, so we recommend it when you wish to leave the settings to the camera and record without thinking about them.

1 Set the mode dial to [iA].

- The camera will switch to either the most recently used of Intelligent Auto Mode or Intelligent Auto Plus Mode. At the time of purchase, the mode is set to Intelligent Auto Plus Mode. (P25)

2 Align the screen with the subject.

- When the camera identifies the optimum scene, the icon of the scene concerned is displayed in blue for 2 seconds, after which its color changes to the usual red. (Automatic scene detection)

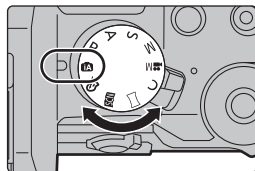

■ Switching between Intelligent Auto Plus Mode and Intelligent Auto Mode

1 Press [MENU/SET].



2 Press ◀.

3 Press ▲/▼ to select the [iA+] or [iA] tab.

4 Press ▶ to select [iA+] or [iA] and then press [MENU/SET].

- If [DISP.] is pressed, the description of the selected mode will be displayed.

Recording night scenes ([iHandheld Night Shot])

When [iHandheld Night Shot] is set to [ON] and [iA+] is detected while taking handheld night shots, pictures of the night scenery will be taken at a high burst speed and composed into a single picture.

This mode is useful if you want to take stunning night shots with minimal jitter and noise, without using a tripod.

MENU →  **[Rec]** → **[iHandheld Night Shot]** → **[ON]/[OFF]**

Combining pictures into a single picture with rich gradation ([iHDR])

When [iHDR] is set to [ON] and there is, for example, strong contrast between the background and the subject, multiple still pictures are recorded with differing exposures and combined to create a single still picture rich in gradation.

[iHDR] works automatically as needed. When it does, [HDR] is displayed on the screen.

MENU →  **[Rec]** → **[iHDR]** → **[ON]/[OFF]**

Taking a picture with a blurred background (Defocus Control)

Recording Mode:  

You can easily set the blurriness of the background while checking the screen.

- 1 Press [Fn4] to display the setting screen.
- 2 Set the blurriness by rotating the rear dial.

- If you press [MENU/SET], you can return to the recording screen.

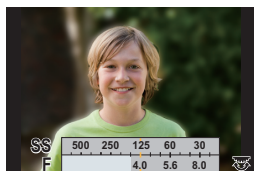



Recording images by changing the brightness or color tone

Recording Mode: 

This mode enables you to change the brightness and color tone to your preferred settings from the ones set by the camera.

Setting brightness

- 1 Press [].
- 2 Rotate the rear dial to adjust brightness.
 - Press [] again to return to the recording screen.

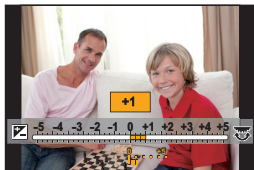

Setting color

- 1 Press  to display the setting screen.
- 2 Rotate the rear dial to adjust color.
 - This will adjust the color of the image from a reddish color to a bluish color.
 - Press [MENU/SET] to return to the recording screen.



Recording motion pictures with manually set aperture value/shutter speed (Creative Video Mode)

Recording Mode: 

It is possible to manually change the aperture and shutter speed and record motion pictures.

1 Set the mode dial to .

2 Select the menu. (P23)

MENU →  [Motion Picture] → [Exposure Mode]

3 Press **▲/▼** to select [P], [A], [S] or [M], and then press [MENU/SET].

- The operation for changing the aperture value or shutter speed is the same as the operation for setting the mode dial to **P**, **A**, **S** or **M**.

4 Start recording.

- Press the motion picture button or the shutter button to start recording a motion picture. (Still pictures cannot be taken.)

5 Stop recording.

- Press the motion picture button or the shutter button to stop recording a motion picture.

Setting the Picture Quality and Size

Setting the aspect ratio of pictures

Applicable modes:

This allows you to select the aspect ratio of the pictures to suit printing or the playback method.

MENU → **[Rec]** → **[Aspect Ratio]**

[4:3]	[Aspect Ratio] of a 4:3 TV
[3:2]	[Aspect Ratio] of a 35 mm film camera
[16:9]	[Aspect Ratio] of a high-definition TV, etc.
[1:1]	Square aspect ratio

• The ends of the recorded pictures may be cut at printing so check before printing.

Setting the number of pixels

Applicable modes:

Set the number of pixels.

The higher the numbers of pixels, the finer the detail of the pictures will appear even when they are printed onto large sheets.

MENU → **[Rec]** → **[Picture Size]**

When the aspect ratio is [4:3].

Settings	Image size
[L] (16M)	4592×3448
[EXM] (8M)	3232×2424
[EXS] (4M)	2272×1704

When the aspect ratio is [3:2].

Settings	Image size
[L] (14M)	4592×3064
[EXM] (7M)	3232×2160
[EXS] (3.5M)	2272×1520

When the aspect ratio is [16:9].

Settings	Image size
[L] (12M)	4592×2584
[EXM] (8M)	3840×2160
[EXS] (2M)	1920×1080

When the aspect ratio is [1:1].









Settings	Image size
[L] (11.5M)	3424×3424
[EXM] (6M)	2416×2416
[EXS] (3M)	1712×1712

Setting the compression rate of pictures ([Quality])

Applicable modes:       

Set the compression rate at which the pictures are to be stored.

MENU →  **[Rec]** → **[Quality]**

Settings	File format	Description of settings
	JPEG	A JPEG image in which image quality was given priority.
		A standard image quality JPEG image. This is useful for increasing the number of shots without changing the number of pixels.
	RAW+JPEG	You can record a RAW image and a JPEG image ( or ) simultaneously.*1
		
[RAW]	RAW	You can only record RAW images.*2 [RAW] images are recorded with a smaller data volume than  or  .

*1 If you delete a RAW file from the camera, the corresponding JPEG image will also be deleted.

*2 It is fixed to maximum recordable pixels ([L]) for each image aspect ratio.

- You can process RAW images in [RAW Processing] in the [Playback] menu. (P40)
- To process and edit RAW files on a PC, use the software "SILKYPIX Developer Studio" by Ichikawa Soft Laboratory on the DVD (supplied).

Adjusting Focus Manually

Applicable modes: 

Use this function when you want to fix the focus or when the distance between the lens and the subject is determined and you do not want to activate Auto Focus.

**When using an interchangeable lens (H-FS1442A/
H-FS45150/H-FS14140) with a focus ring**

Rotate to **A side:**

Focuses on nearby subject

Rotate to **B side:**

Focuses on faraway subject

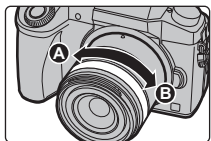

1 Set the focus mode lever to [MF].

2 Press ◀ ().

3 Press ▲/▼/◀/▶ to adjust the focus position, and press [MENU/SET].

- The assist screen is displayed, enlarging the area. (MF Assist)
- Pressing [DISP.] resets the focus position back to the center.

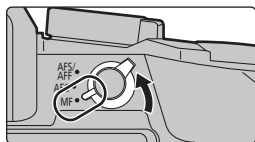



4 Adjust the focus.

- (A) Indicator for ∞ (infinity)
- (B) MF Assist (enlarged screen)
- (C) Peaking
- (D) MF Guide

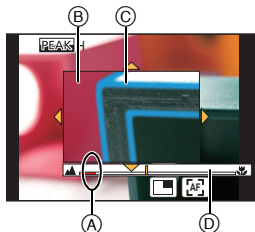
- The in-focus portions will be highlighted. (Peaking)
- You can check whether the point of focus is to the near side or to the far side. (MF Guide)



You can perform the following operations:

Button operation	Touch operation	Description of operation
▲/▼/◀/▶	Dragging	Moves the enlarged area
	Pinching out/in	Enlarges/reduces the screen in small steps.
	—	Enlarges/reduces the screen in large steps.
—		Switches the enlarged display (windowed/full screen)
[DISP.]	[Reset]	Resets the area to be enlarged back to the center.

5 Press the shutter button halfway.

- The assist screen will close. The recording screen will be displayed.
- You can also close the assist screen by pressing [MENU/SET].





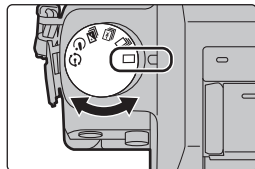

Select a Drive Mode

Applicable modes:   **P** **A** **S** **M**  **C**  

You can change what the camera will do when you press the shutter button.

Rotating the drive mode dial.



 [Single]	When the shutter button is pressed, only one picture is recorded.
 [Burst]	Recordings are made in succession while the shutter button is pressed.
 [4K PHOTO] (P32)	When the shutter button is pressed, a 4K photo is recorded.
 [Auto Bracket]	Each time the shutter button is pressed, recordings are made with different exposure settings according to the Exposure Compensation range.
 [Self Timer]	When the shutter button is pressed, recording takes place after the set time has elapsed.
 [Time Lapse/ Animation]	Pictures are recorded with Time Lapse Shot or Stop Motion Animation.

Recording 4K Photos

Applicable modes:

Press the shutter button to record a 4K photo. You can select the desired moment from a burst of pictures taken at 30 frames/second and save that moment as a picture of 8 million pixels (approx.).

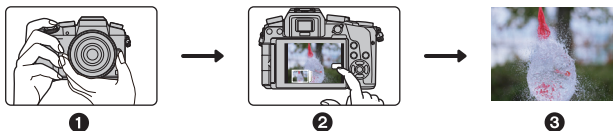

- ① Record a 4K photo. ② Select and save pictures. ③ The picture is complete.

- Use a UHS Speed Class 3 card to record 4K photos. (P16)
- When recording 4K photos, the angle of view is slightly narrower.

1 Set the drive mode dial to .

- Settings will be optimized for 4K photo recording. The recording method is set to ([4K Burst]) by default.

2 Select the menu. (P23)

MENU → **[Rec]** → **[4K PHOTO]**

3 Press / to select the item and then press **[MENU/SET]**.

[4K Burst]	<p>For capturing the best shot of a fast-moving subject (e.g., sports, aeroplanes, trains)</p> <p>Burst recording is performed while the shutter button is pressed and held. The shutter sound will be heard repeatedly.</p> <p>Ⓐ Press and hold Ⓑ Recording is performed</p> <p>Continuous recording length: Up to 29 minutes and 59 seconds*</p>	
[4K Burst(S/S)] “S/S” is an abbreviation of “Start/Stop”.	<p>For capturing unpredictable photo opportunities (e.g., plants, animals, children)</p> <p>Burst recording starts when the shutter button is pressed and stops when pressed again. Start and stop tones will be heard.</p> <p>Ⓒ Start (First) Ⓓ Stop (Second) Ⓔ Recording is performed</p> <p>Continuous recording length: Up to 29 minutes and 59 seconds*</p>	



[4K Pre-Burst]

For recording as needed whenever a photo opportunity arises

(e.g., the moment when a frisbee is caught or a ball is thrown)

Burst recording is performed for approximately 1 second before and after the moment that the shutter button is pressed. The shutter sound will be heard only once.

Ⓕ Approximately 1 seconds

Ⓖ Recording is performed

- The battery drains faster when the drive mode is set to 4K Photo and [4K PHOTO] is set to [] ([4K Pre-Burst]).

Recording length: Approximately 2 seconds

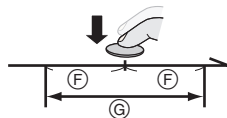

- * Recording will continue without interruption even when the file size exceeds 4 GB, but the file will be divided and saved/played back separately.

4 Press the shutter button halfway.

- The recording screen will be displayed. You can also perform the same operation by pressing and holding [] until the recording screen is displayed.



5 Press the shutter button to perform recording.

- After the 4K burst photo recording, a 4K burst file will be saved. 4K burst files are saved as motion pictures in MP4 format.
- When [Auto Review] is enabled, the picture selection screen will be displayed automatically. To continue recording, press the shutter button halfway to display the recording screen.

Selecting pictures from 4K burst file and saving

- **The picture will be saved in JPEG format.**
- The picture will be saved with recording information (Exif information), including its shutter speed, aperture and ISO sensitivity information.



Setting [Playback Mode] in the [Playback] menu to [4K PHOTO] enables you to play back only 4K burst files and pictures created from them.

- For details, refer to the “Owner’s Manual for advanced features (PDF format)”.

Recording Motion Picture

Applicable modes:   **P** **A** **S** **M**  **C**  

This camera can record full high definition motion pictures compatible with the AVCHD format or motion pictures recorded in MP4.

In addition, the camera can record 4K motion pictures in MP4. (P37)

Audio will be recorded in stereo.

1 Start recording by pressing the motion picture button.

- (A) Elapsed recording time
- (B) Available recording time

- Recording of motion picture appropriate for each mode is possible.
- The recording state indicator (red)  will flash while recording motion pictures.
- If approximately 1 minute elapses without an operation being performed, part of the display will disappear. Press [DISP.] or touch the monitor to make the display reappear.
- Release the motion picture button right after you press it.

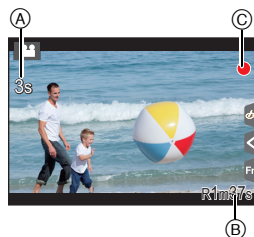
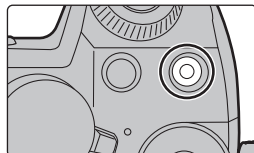

2 Stop the recording by pressing the motion picture button again.

- Still picture recording is also possible during the motion picture recording by fully pressing the shutter button.

- When the ambient temperature is high or motion picture is recorded continuously, the camera may display [] and stop the recording to protect itself. Wait until the camera cools down.
- It is recommended to use a fully charged battery or AC adaptor (DMW-AC10PP: optional) when recording motion pictures.
- If while recording motion pictures using the AC adaptor (DMW-AC10PP: optional) the power supply is cut off due to a power cut or if the AC adaptor (DMW-AC10PP: optional) is disconnected etc., the motion picture will not be recorded.
- These times are for an ambient temperature of 23 °C (73.4 °F) and a humidity of 50%RH. Please be aware that these times are approximate.
- Actual recordable time is the time available for recording when repeating actions such as turning this unit on and off, starting/stopping recording, etc.
- MP4 motion pictures with a [Rec Quality] size of [FHD], [HD] or [VGA]:
Recording stops when the continuous recording time exceeds 29 minutes and 59 seconds or the file size exceeds 4 GB.
 - Since the file size becomes larger with [FHD], recording with [FHD] will stop before 29 minutes 59 seconds.
- MP4 motion pictures with a [Rec Quality] size of [4K]:
Recording stops when the continuous recording time exceeds 29 minutes and 59 seconds. (You can continue recording without interruption even if the file size exceeds 4 GB, but the motion picture file will be divided and recorded/played back separately.)

■ Setting the format, size and recording frame rate

MENU →  **[Motion Picture]** → **[Rec Format]**

[AVCHD] This data format is suitable for when playing back on a high-definition TV, etc.

[MP4] This data format is suitable for when playing back on a PC, etc.

MENU →  **[Motion Picture]** → **[Rec Quality]**

When [AVCHD] is selected

Item	Size	Recording frame rate	Sensor output	Bit rate
[FHD/28M/60p]*	1920×1080	60p	60 frames/second	28 Mbps
[FHD/17M/60i]	1920×1080	60i	60 frames/second	17 Mbps
[FHD/24M/30p]	1920×1080	60i	30 frames/second	24 Mbps
[FHD/24M/24p]	1920×1080	24p	24 frames/second	24 Mbps

* AVCHD Progressive

When [MP4] is selected

Item	Size	Recording frame rate	Sensor output	Bit rate
[4K/100M/30p]	3840×2160	30p	30 frames/second	100 Mbps
[4K/100M/24p]	3840×2160	24p	24 frames/second	100 Mbps
[FHD/28M/60p]	1920×1080	60p	60 frames/second	28 Mbps
[FHD/20M/30p]	1920×1080	30p	30 frames/second	20 Mbps
[HD/10M/30p]	1280×720			10 Mbps
[VGA/4M/30p]	640×480			4 Mbps

Recording motion pictures in 4K

Applicable modes:   **P** **A** **S** **M**  **C**   

You can create finely-detailed motion pictures in 4K by recording motion pictures with their size set to [4K] in [Rec Quality].

- When recording motion pictures in 4K, use a card rated as UHS Speed Class 3. (P16)
- The angle of view of motion pictures in 4K is narrower than those of motion pictures in other sizes.

To record motion pictures in 4K:

- 1 Set [Rec Format] in the [Motion Picture] menu to [MP4]. (P36)
- 2 Set [Rec Quality] in the [Motion Picture] menu to [4K/100M/30p] or [4K/100M/24p]. (P36)
- 3 Start recording by pressing the motion picture button.
- 4 Stop the recording by pressing the motion picture button again.

Playing Back Pictures

- 1 Press [▶].
- 2 Press ◀/▶.

- ◀: Play back the previous picture
- ▶: Play back the next picture



Sending an image to a web service

If you press ▼ when displaying images one by one, you can easily send an image to a web service.

- For details, refer to the “Owner’s Manual for advanced features (PDF format)”.

Playing Back Motion Pictures

This unit was designed to play motion pictures using the AVCHD and MP4 formats.

- Motion pictures are displayed with the motion picture icon (▶/⏮).

Press ▲ to play back.

- Ⓐ Motion picture recording time

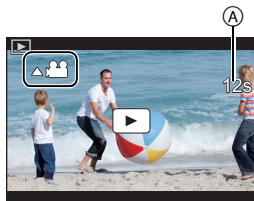

Operations during Motion Picture Playback

Button operation	Touch operation	Description of operation
▲	▶/⏮	Play/Pause
◀	◀◀	Fast rewind ^{*1}
	◀	Frame-by-frame rewind (while pausing) ^{*2}
🔊	−	Reduce volume level

Button operation	Touch operation	Description of operation
▼	■	Stop
▶	▶▶	Fast forward ^{*1}
	▶	Frame-by-frame forward (while pausing)
🔊	+	Increase volume level

* 1 The fast forward/rewind speed increases if you press ▶/◀ again.



* 2 When a motion picture recorded with [AVCHD] is rewound frame-by-frame, its frames will be shown in intervals of approximately 0.5 seconds.

- If you press [MENU/SET] during a pause, you can create a picture from a motion picture.

Deleting Pictures

Once deleted, pictures cannot be recovered.

To delete a single picture

- In Playback Mode, select the picture to delete and then press [].**
 - The same operation can be performed by touching [].

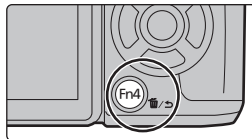

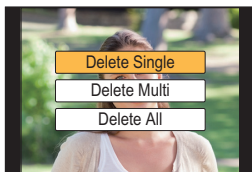

- Press ▲ to select [Delete Single] and then press [MENU/SET].**
 - Confirmation screen is displayed.
Picture is deleted by selecting [Yes].



To delete multiple pictures (up to 100*) or all the pictures

- * Picture groups are treated as a single picture.
(All the pictures in the selected picture group will be deleted.)

- In Playback Mode, press [].**
- Press ▲/▼ to select [Delete Multi] or [Delete All] and then press [MENU/SET].**
 - [Delete All] → Confirmation screen is displayed.
Pictures are deleted by selecting [Yes].
 - It is possible to delete all pictures except the ones set as favorite when [All Delete Except Favorite] is selected with the [Delete All] set.

- (When [Delete Multi] is selected)**
Press ▲/▼/◀/▶ to select the picture, and then press [MENU/SET] to set. (Repeat this step.)
 -  appears on the selected pictures.
If [MENU/SET] is pressed again, the setting is canceled.



- (When [Delete Multi] is selected)**
Press ◀ to select [OK], and then press [MENU/SET] to execute.
 - Confirmation screen is displayed.
Pictures are deleted by selecting [Yes].

Using the [Playback] Menu

[RAW Processing]

You can process the pictures taken in RAW format. The processed pictures will be saved in JPEG format. You can check how effects are applied to each picture while processing it.

1 Select the menu. (P23)

[MENU] → [▶] [Playback] → [RAW Processing]

2 Select RAW images with ◀/▶, and then press [MENU/SET].

3 Press ▲/▼ to select an item.



[White Balance]

[Highlight]

[i.Resolution]

[Exposure Comp.]

[Shadow]

[Sharpness]

[Photo Style]

[Saturation]/[Color Tone]

[Setup]

[i.Dynamic]

[Filter Effect]

[Contrast]

[Noise Reduction]

4 Press [MENU/SET] and set.

- The setting method differs according to the item.

5 Press [MENU/SET].



- This operation returns you to the screen in step 3. To set other items, repeat steps 3 through 5.

6 Select [Begin Processing] with ▲/▼, and then press [MENU/SET].

- Confirmation screen is displayed. It is executed when [Yes] is selected. Exit the menu after it is executed.

■ How to set each item

When you select an item, the setting screen will be displayed.

Button operation	Touch operation	Description of operation
	Dragging	Selects a setting.
	[WB K Set]	Displays the screen that lets you set the color temperature. (only when [White Balance] is set to [K])
	[Adjust.]	Displays the screen that lets you fine-adjust the White Balance. (only when [White Balance] is set)
[DISP.]	[DISP.]	Displays the comparison screen.
[MENU/SET]	[Set]	Sets the adjusted level and returns you to the item selection screen.

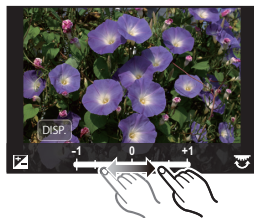



- When [Noise Reduction], [i.Resolution] or [Sharpness] is selected, the comparison screen cannot be displayed.
- If you touch the picture twice, the picture will be enlarged. If you touch the picture twice when it is enlarged, it will be reduced to the original size.

On the comparison screen, you can use the following operations to make adjustments:

Ⓐ Current setting

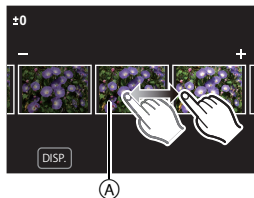
Button operation	Touch operation	Description of operation
	Dragging	Selects a setting.
[DISP.]	[DISP.]	Returns you to the setting screen.
[MENU/SET]	[Set]	Sets the adjusted level and returns you to the item selection screen.



- If you touch the picture at the center, it will be enlarged. If you touch , the picture will be reduced to the original size.

[Setup] setting

When you select an item, the screen that asks you to select [Reinstate Adjustments], [Color Space], or [Picture Size] will be displayed.

- 1 Press **▲/▼** to select an item, and press **[MENU/SET]**.
 - If you select [Reinstate Adjustments], a confirmation screen will be displayed. Selecting [Yes] will execute the operation and return you to the item selection screen.
- 2 Press **▲/▼** to select a setting, and press **[MENU/SET]**.

What you can do with the Wi-Fi® function

- The camera cannot be used to connect to a public wireless LAN connection.

Controlling with a Smartphone/Tablet (P42)

- Recording with a smartphone (P44)
- Playing back pictures in the camera (P44)
- Saving images stored in the camera (P45)
- Sending images to an SNS (P45)
- Writing location information on images stored in the camera (P45)
- Combining motion pictures recorded with Snap Movie according to your preference on a smartphone (P46)

Displaying pictures on a TV

Printing Wirelessly

When sending images to AV device

When sending images to PC

Using Web services

This owner's manual refer to both smartphones and tablets as “smartphones” from this point on unless noted otherwise.

- For details, refer to the “Owner’s Manual for advanced features (PDF format)”.

■ About the [Wi-Fi] button

In this owner’s manual, a function button to which [Wi-Fi] is assigned is referred to as the [Wi-Fi] button. (At the time of purchase, [Wi-Fi] is assigned to [Fn6].)

- Refer to P24 for details about the function button.



Steps for pressing [Wi-Fi]

- 1 Touch [Fn].
- 2 Touch [Fn6].

Controlling with a Smartphone/Tablet

Installing the smartphone/tablet app “Image App”

The “Image App” is an application provided by Panasonic.

• OS

App for Android™: Android 4.0 or higher

App for iOS: iOS 6.0 or higher

(Please note that the iPhone 3GS is not supported.)

- 1 Connect the smartphone to a network.
- 2 (Android) Select “Google Play™ Store”.
(iOS) Select “App StoreSM”.
- 3 Enter “Panasonic Image App” or “LUMIX” into the search box.
- 4 Select “Panasonic Image App”  and install it.

- Use the latest version.
- Supported OSs are current as of May 2015 and are subject to change.
- Read the [Help] in the “Image App” menu for further details on how to operate.
- The service may not be able to be used properly depending on the type of smartphone being used.

For information on the “Image App”, refer to the support site below.

<http://panasonic.jp/support/global/cs/dsc/>

(This Site is English only.)

- When downloading the app on a mobile network, high packet communication fees may be incurred depending on the details of your contract.

Connecting to a smartphone/tablet

For both iOS devices (iPhone/iPod touch/iPad) and Android devices

Connecting without entering the password

You can easily set up a direct connection to your smartphone without entering a password.

- 1 Select the menu on the camera. (P23)

MENU →  **[Setup]** → **[Wi-Fi]** → **[Wi-Fi Function]** → **[New Connection]** → **[Remote Shooting & View]**

- The information required for connecting the smartphone to this unit (SSID) is displayed.

Ⓐ SSID

- You can also display the information by pressing [Wi-Fi] on the camera.

- 2 Turn on the Wi-Fi function in the setting menu of the smartphone.

- 3 Select the SSID displayed on the screen of the camera.

- 4 On the smartphone, start “Image App”.

- The connection confirmation screen is displayed on the camera. Select [Yes]. (Only when connecting for the first time)



When [Wi-Fi Password] is set to the default setting [OFF], third parties may intercept Wi-Fi radio waves and collect the content of communications. Set [Wi-Fi Password] to [ON] to enable the password.

- For details, refer to the “Owner’s Manual for advanced features (PDF format)”.

For both iOS devices (iPhone/iPod touch/iPad) and Android devices

Terminating the connection

After use, terminate the connection to the smartphone.

1 Select the menu on the camera. (P23)

MENU →  [Setup] → [Wi-Fi] → [Wi-Fi Function] → [Yes]

- You can also terminate the connection by pressing [Wi-Fi] on the camera.

2 On the smartphone, close “Image App”.

(If you are using an iOS device)

On the screen of “Image App”, press the home button to close the app.

(If you are using an Android device)

On the screen of “Image App”, press the return button twice to close the app.

Taking images via a smartphone/tablet (remote recording)

1 Connect to a smartphone. (P43)

2 Operate the smartphone.

① Select [].

② Record an image.

- The recorded images are saved in the camera.
- Some settings are not available.

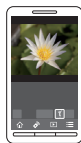

Playing back images in the camera

1 Connect to a smartphone. (P43)

2 Operate the smartphone.

① Select [].

② Touch the image to enlarge it.



Saving images stored in the camera

1 Connect to a smartphone. (P43)

2 Operate the smartphone.



① Select [].

② Touch and hold an image, and drag it to save it.

- The function can be assigned to the top, bottom, left or right according to your preference.
- Pictures in RAW format, AVCHD motion pictures, MP4 motion pictures with a [Rec Quality] size of [4K], and 4K burst files cannot be saved.
- 3D pictures (MPO format) will be saved as 2D pictures (JPEG format).

Sending images in the camera to an SNS

1 Connect to a smartphone. (P43)

2 Operate the smartphone.



① Select [].

② Touch and hold an image, and drag it to send it to an SNS, etc.

- The image is sent to a web service such as an SNS.

- The function can be assigned to the top, bottom, left or right according to your preference.

Adding location information to images stored in the camera from a smartphone/tablet

You can send location information acquired with a smartphone to the camera. **After sending the information, you can also write it on images stored in the camera.**

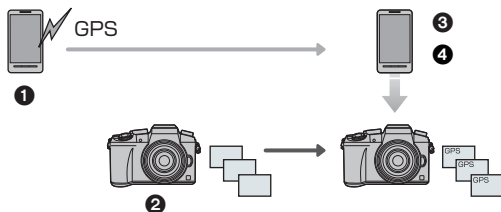

- ① Start recording location information
- ② Start recording images
- ③ Finish recording the location information
- ④ Sending and writing location information



■ Operate the smartphone

- 1 Connect to a smartphone. (P43)
- 2 Select [].
- 3 Select [Geotagging].
- 4 Select an icon.



	<p>Start/stop recording location information.</p> <ul style="list-style-type: none"> • The smartphone battery drains faster while location information is being recorded. When recording of location information is not necessary, stop it.
	<p>Sending and writing location information.</p> <ul style="list-style-type: none"> • Follow the on-screen messages to operate the smartphone. • Images with location information are indicated with [GPS].

Combining motion pictures recorded with Snap Movie according to your preference on a smartphone/tablet

Using a smartphone, you can combine motion pictures recorded with the camera's [Snap Movie] function. Music can be added to motion pictures to be combined. In addition, you can save the combined motion picture or upload it on a web service.

- 1 Connect to a smartphone. (P43)
- 2 Operate the smartphone.

- 1 Select [].
- 2 Select [Snap Movie].



- [Snap Movie] motion pictures with recent recording dates will be selected and automatically sent to the smartphone.
 - When motion pictures with recent recording dates are not available, a screen that lets you select motion pictures will be displayed. Select motion pictures and send them.
- 3 Edit the motion pictures.
 - Read the [Help] in the "Image App" menu for further details on how to operate.

- [Snap Movie] of the "Image App" requires a smartphone that supports Android OS 4.3 or higher.
- The iPhone 4 and iPod touch (4th generation) do not support [Snap Movie] of the "Image App".

About the supplied software

The supplied DVD includes the following software.
Install the software on to your computer before use.

- **PHOTOfunSTUDIO 9.7 PE** (Windows Vista/Windows 7/Windows 8/Windows 8.1)
- **SILKYPIX Developer Studio 4.3 SE**
(Windows Vista/Windows 7/Windows 8/Windows 8.1, Mac OS X v10.6 to v10.10)

For details on how to use the SILKYPIX Developer Studio, refer to the “Help” or the Ichikawa Soft Laboratory’s support website:
<http://www.isl.co.jp/SILKYPIX/english/p/support/>

- **LoiLoScope 30 day full trial version** (Windows Vista/Windows 7/Windows 8/Windows 8.1)

For more information on how to use LoiLoScope, read the LoiLoScope manual available for download at the link below.
Manual URL: <http://loilo.tv/product/20>

■ Installing supplied software

- Before inserting the DVD, close all running applications.

1 Check the environment of your PC.

- For details about information such as the operating environment or operating method, refer to the “Owner’s Manual for advanced features (PDF format)” or the operating instructions for the respective software programs.

2 Insert the DVD with the supplied software.

- If the automatic playback screen is displayed, you can display the menu by selecting and executing [Launcher.exe].
- In Windows 8/Windows 8.1, you can display the menu by clicking a message that is displayed after inserting the DVD and then selecting and executing [Launcher.exe].
- You can also display the menu by double-clicking [SFMXXXX] in [Computer] (XXXX differs depending on the model).

3 Click [Applications].

4 Click on the [Recommended Installation] on the install menu to install.

- Proceed with installation according to messages appearing on the screen.

- The software compatible with your PC will be installed.
- On the Mac, SILKYPIX can be installed manually.
 - 1 Insert the DVD with the supplied software.
 - 2 Double-click the application folder on the DVD.
 - 3 Double-click on the automatically displayed folder.
 - 4 Double-click the icon in the application folder.



Not available in these cases:

- “PHOTOfunSTUDIO” and “LoiLoScope” are not compatible with Mac.

Monitor Display/Viewfinder Display

- The following images are examples of when the display screen is set to [] (monitor style) in the monitor.



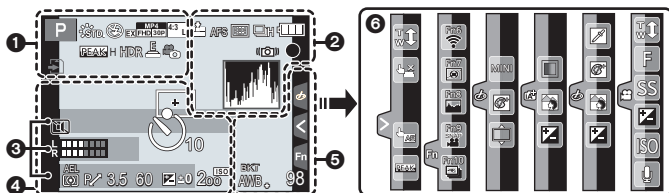



























In recording



1

	Recording Mode (P20)
C 1	Custom settings
	Photo Style
	Flash Mode
	Flash
	Extended Tele Conversion (when recording motion pictures)
	Recording format/Recording quality (P36)
	Snap Movie
	Picture size/Aspect Ratio (P28)
	Extended Tele Conversion (when taking still pictures)

	Image size (Panorama Shot Mode)
	Image effect (filter) adjustment display
EXPS	Image effect (filter) setting
	Card (displayed only during recording)
8m30s	Elapsed recording time*1 (P34)
	Simultaneous recording indicator
	Automatic viewfinder/monitor switching (P22)
	Peaking
	Highlight Shadow
HDR	HDR/iHDR (P26)
	Multi exposure
	Digital Zoom
	Electronic shutter
	Picture Mode (Photo Priority)
	Overheat indicator (P54, 55)

2	 RAW	Quality (P29)
	AFS AFF AFC MF	Focus Mode
		AF Mode
		Pull Focus
		Face Recognition
	AFL	AF Lock
		Burst
		4K Photo (P32)
		Auto Bracket
		Self-timer
		Battery indication
		Optical Image Stabilizer ⁺²
		Jitter alert
		Recording state (Flashes red./ Focus (Lights green.) (P19)
		Focus (Under low illumination)
		Focus (Starlight AF)
		Connected to Wi-Fi
		Histogram
3	Name ⁺³	
	Number of days that have passed since the departure date ⁺⁴	
	Age ⁺³	
	Location ⁺⁴	
	Current date and time/Travel destination setting ⁺⁴ : 	
	Exposure meter	
	Focal distance display	
	Step zoom	
4		AF area
	+	Spot metering target
	+	Center marker display
		Self-timer ⁺⁵
		Mic level display
		Mic Level Limiter (OFF)
		Silent Mode
		External Microphone
	AEL	AE Lock
		Metering Mode
		Program Shift
	3.5	Aperture value (P19)
	60	Shutter speed (P19)
		Exposure compensation value
		Brightness (P26)
		Manual Exposure Assistance
	200 ^{ISO}	ISO sensitivity
5		White Balance Bracket
		White Balance Fine Adjustment
		White Balance
		Color (P26)
	98	Number of recordable pictures ⁺⁶
	R8m30s	Available recording time ^{+1, 6}

6

Touch tab

		Touch zoom				
		Touch Shutter				
		Touch AE				
		Peaking				
						Function button (P24)
		Color (P26)				
		Defocus control function (P26)				
		Brightness (P26)				
		Type of defocus ([Miniature Effect])				
		One point color				
		Position of the light source				
		Image effect (filter) adjustment				
		Image effect (filter)				
		Aperture value (P19)				
		Shutter speed (P19)				
		ISO sensitivity				
		Microphone level adjustment				

*1 h: hour, m: minute, s: second

*2 Only available when a lens that supports the Stabilizer function is attached.

*3 This is displayed for about 5 seconds when the camera is turned on if the [Profile Setup] setting is set.

*4 This is displayed for about 5 seconds when the camera is turned on, after setting the clock and after switching from Playback Mode to Recording Mode.

*5 This is displayed during countdown.

*6 It is possible to switch the display between the number of recordable pictures and available recording time with the [Remaining Disp.] setting in the [Custom] menu.

In recording

On-monitor recording information

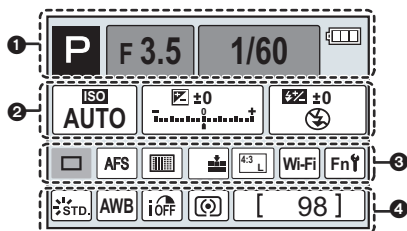

1		Recording Mode (P20)
	F3.5	Aperture value (P19)
	1/60	Shutter speed (P19)
		Battery indication

2	ISO AUTO	ISO sensitivity
		Exposure compensation value
		Brightness (P26)
		Manual Exposure Assistance
		Flash Mode
		Flash

3		Single (P31)
		Burst
		4K Photo (P32)
		Auto Bracket
		Self-timer
	AFS AFF AFC MF	Focus Mode (P30)
		AF Mode
		Quality (P29)
		Picture size/Aspect Ratio (P28)
	Wi-Fi	Wi-Fi (P42)
	Fn	Function button setting (P24)

4		Photo Style
		White Balance
		Intelligent Dynamic Range Control
		Metering Mode
	98	Number of recordable pictures
	R8m30s	Available recording time

Menu list

To display explanations of the menu items.

When [Menu Information] in the [Setup] menu is set to [ON], explanations of the menu items and settings are displayed on the menu screen.

Explanations of the menu

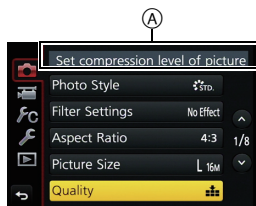

- [Photo Style], [Filter Settings], [AFS/AFF], [Metering Mode], [Highlight Shadow], [i.Dynamic], [i.Resolution], [Diffraction Compensation] and [Digital Zoom] are common to both the [Rec] menu and [Motion Picture] menu. Changing these settings in one of these menus is reflected in other menu.

[Rec]

This menu lets you set the aspect ratio, number of pixels, 4K Photo and other aspects of the pictures you are recording.

[Photo Style]	[Highlight Shadow]	[ISO Limit Set]
[Filter Settings]	[i.Dynamic]	[ISO Increments]
[Aspect Ratio]	[i.Resolution]	[Extended ISO]
[Picture Size]	[i.Handheld Night Shot]	[Long Shtr NR]
[Quality]	[i.HDR]	[Shading Comp.]
[AFS/AFF]	[HDR]	[Diffraction Compensation]
[Metering Mode]	[Multi Exp.]	[Ex. Tele Conv.]
[Burst Rate]	[Panorama Settings]	[Digital Zoom]
[4K PHOTO]	[Electronic Shutter]	[Color Space]
[Auto Bracket]	[Shutter Delay]	[Stabilizer]
[Self Timer]	[Flash]	[Face Recog.]
[Time Lapse/Animation]	[Red-Eye Removal]	[Profile Setup]

[Motion Picture]

This menu lets you set the [Rec Format], [Rec Quality], and other aspects for motion picture recording.

[Photo Style]	[Metering Mode]	[Silent Operation]
[Filter Settings]	[Highlight Shadow]	[Mic Level Disp.]
[Snap Movie]	[i.Dynamic]	[Mic Level Adj.]
[Rec Format]	[i.Resolution]	[Special Mic.]
[Rec Quality]	[Diffraction Compensation]	[Mic Level Limiter]
[Exposure Mode]	[Luminance Level]	[Wind Noise Canceller]
[AFS/AFF]	[Ex. Tele Conv.]	[Wind Cut]
[Picture Mode]	[Digital Zoom]	[Lens Noise Cut]
[Continuous AF]	[Flkr Decrease]	

[Custom]

Operation of the unit, such as displaying of the screen and button operations, can be set up according to your preferences. Also, it is possible to register the modified settings.

[Cust.Set Mem.]	[MF Assist Display]	[Remaining Disp.]
[Silent Mode]	[MF Guide]	[Auto Review]
[AF/AE Lock]	[Peaking]	[Fn Button Set]
[AF/AE Lock Hold]	[Histogram]	[Q.MENU]
[Shutter AF]	[Guide Line]	[Dial Set.]
[Half Press Release]	[Center Marker]	[Video Button]
[Quick AF]	[Highlight]	[Power Zoom Lens]
[Eye Sensor AF]	[Zebra Pattern]	[Eye Sensor]
[Pinpoint AF Time]	[Monochrome Live View]	[Touch Settings]
[Pinpoint AF Display]	[Constant Preview]	[Touch Scroll]
[AF Assist Lamp]	[Expo.Meter]	[Menu Guide]
[Direct Focus Area]	[LVF Disp.Style]	[Shoot w/o Lens]
[Focus/Release Priority]	[Monitor Disp. Style]	
[AF+MF]	[Monitor Info. Disp.]	
[MF Assist]	[Rec Area]	

[Setup]

This menu lets you perform the clock settings, select the operating beep tone settings and set other settings which make it easier for you to operate the camera.

You can also configure the settings of Wi-Fi related functions.

[Clock Set]	[Economy]	[Exposure Comp. Reset]
[World Time]	[USB Mode]	[No.Reset]
[Travel Date]	[TV Connection]	[Reset]
[Wi-Fi]	[Menu Resume]	[Reset Wi-Fi Settings]
[Beep]*	[Menu Background]	[Pixel Refresh]
[Live View Mode]	[Menu Information]	[Sensor Cleaning]
[Monitor Display]/[Viewfinder]	[Language]	[Format]
[Monitor Luminance]	[Version Disp.]	

* This allows you to set the volume for electronic sound and the electronic shutter sound.

[Playback]

This menu lets you set the Protection, Cropping or Print Settings, etc. of recorded pictures.

[2D/3D Settings]	[Text Stamp]	[Rotate Disp.]
[Slide Show]	[Video Divide]	[Favorite]
[Playback Mode]	[Time Lapse Video]	[Print Set]
[Location Logging]	[Stop Motion Video]	[Protect]
[RAW Processing]	[Resize]	[Face Rec Edit]
[Clear Retouch]	[Cropping]	[Picture Sort]
[Title Edit]	[Rotate]	[Delete Confirmation]

Troubleshooting

First, try out the following procedures.



If the problem is not resolved, it may be improved by selecting [Reset] on the [Setup] menu.

- Please also refer to the “Owner’s Manual for advanced features (PDF format)”, which describes more detailed information.



**The camera cannot be operated even when it is turned on.
The camera turns off immediately after it is turned on.**

- The battery is exhausted.
→ Charge the battery.
- If you leave the camera on, the battery will be exhausted.
→ Turn the camera off frequently by using the [Economy] etc.

The battery becomes flat too quickly.

- Is the drive mode set to 4K Photo and [4K PHOTO] set to [] ([4K Pre-Burst])? When [] ([4K Pre-Burst]) is selected, the battery drains faster.
→ Select [] ([4K Burst]) only when recording.

**Taking pictures is not possible.
The shutter will not operate immediately when the shutter button is pressed.**

- When the drive mode is set to 4K Photo and [4K PHOTO] in the [Rec] menu is set to [] ([4K Pre-Burst]), the camera temperature rises. In some cases, the camera may display [], switch to [] ([4K Burst]) and stop the recording to protect itself. Wait until the camera cools down.

The subject is not focused properly.

- The subject is beyond the focus range of the camera.
- There is camera shake (jitter) or the subject is moving slightly.
- Is [Focus/Release Priority] in the [Custom] menu set to [RELEASE]?
- Is [Shutter AF] in the [Custom] menu set to [OFF]?
- Is the AF Lock applied incorrectly?

**The recorded picture is blurred.
The Optical Image Stabilizer is not effective.**

- The shutter speed will become slower and the Optical Image Stabilizer function may not work properly when taking pictures especially in dark places.
→ We recommend holding the camera firmly with both hands when taking pictures.
→ We recommend using a tripod and the self-timer when taking pictures with a slow shutter speed.
- Are you using a lens which supports the Stabilizer function?
- When a moving subject is recorded with the electronic shutter, the subject may appear distorted on the picture.

Striping or flicker may appear under lighting such as fluorescent lighting and LED lighting fixture.



- This is characteristic of MOS sensors which serve as the camera's pickup sensors.
This is not a malfunction.
- Are you taking pictures with the electronic shutter?
→ When using the electronic shutter, lowering the shutter speed may reduce the effect of the horizontal stripes.



The brightness or the hue of the recorded picture is different from the actual scene.

- When recording under fluorescent or LED lighting fixture, etc., increasing the shutter speed may introduce slight changes to brightness and color. These are a result of the characteristics of the light source and do not indicate a malfunction.
- When recording subjects in extremely bright locations or recording under fluorescent lighting, LED lighting fixture, mercury lamp, sodium lighting, etc., the colors and screen brightness may change or horizontal striping may appear on the screen.

4K photo recording stops before finishing.

- When the ambient temperature is high or recording with [] ([4K Burst]) or [] ([4K Photo]) of the 4K Photo function is performed continuously, the camera may display [] and stop the recording to protect itself. Wait until the camera cools down.

Recording motion pictures is not possible.

- You may not be able to record for a short while after turning this unit on when using a large capacity card.

Motion picture recording stops in the middle.

- When the ambient temperature is high or motion picture is recorded continuously, the camera may display [] and stop the recording to protect itself. Wait until the camera cools down.

The screen may be blacked out momentarily, or the unit may record noise.

- Depending on the environment at the time of motion picture recording, the screen may be blacked out momentarily or the unit may record noise due to static electricity or powerful electromagnetic waves (radio towers, high voltage power lines, etc.).

Sometimes it is difficult to focus with Auto Focus when recording 4K motion pictures.

- This phenomenon occurs when the camera is trying to record with highly accurate focus at a reduced Auto Focus speed, and is not a malfunction.

The flash is not activated.

- Is the flash closed?
→ Open the flash.
- When the electronic shutter is used, the flash is not activated.
→ Set [Electronic Shutter] to [OFF].
- When [Silent Mode] is set to [ON], the flash is not activated.
→ Set [Silent Mode] to [OFF].

The flash is activated 2 times.

- (Except for when [Firing Mode] in [Flash] is set to [MANUAL]) The flash is activated 2 times. The interval between the first and second flash is longer when Red-Eye Reduction is set so the subject should not move until the second flash is activated.

The picture is not played back. There are no recorded pictures.

- Is the card inserted?
- Is there a picture on the card?
- Is this a folder or picture which was processed in the PC?
If it is, it cannot be played back by this unit.
→ It is recommended to use the "PHOTOfunSTUDIO" software in the DVD (supplied) to write pictures from PC to card.
- Has [Playback Mode] been set for playback?
→ Change to [Normal Play].

The folder number and the file number are displayed as [—] and the screen turns black.

- Is this a non-standard picture, a picture which has been edited using a PC or a picture which was taken by another make of digital camera?
- Did you remove the battery immediately after picture-taking or did you take the picture using a battery with a low remaining charge?
→ To delete such pictures, make a backup of the data and format the card (P16).

[Thumbnail is displayed] appears on the screen.

- Is it a picture that has been recorded with other equipment?
In such cases, these pictures may be displayed with a deteriorated picture quality.

Motion pictures recorded with this model cannot be played back on other equipment.

- The picture quality or sound quality of recorded motion pictures may be deteriorated even when these are played back with the compatible devices. Also, recording information may not be displayed correctly.

**A Wi-Fi connection cannot be established.
Radio waves get disconnected.
Wireless access point is not displayed.**

■ General tips for using a Wi-Fi connection

- Use within the communication range of the device to be connected.
- Is any device, such as microwave oven, cordless phone, etc., that uses 2.4 GHz frequency operated nearby?
 - Radio waves may get interrupted when used simultaneously. Use them sufficiently away from the device.
- When the battery indicator is flashing red, the connection with other equipment may not start or the connection may be disrupted.
(A message such as [Communication error] is displayed.)
- If you place the camera on a metal table or shelf, the radio waves may be adversely affected. In such cases, you may not be able to establish a connection. Move the camera away from the metal surface.

■ About a wireless access point

- Check if the wireless access point to connect is in operating state.
- The camera may not display or connect to a wireless access point depending on the radio wave condition.
 - Move this unit closer to the wireless access point.
 - Remove the obstacles between this unit and the wireless access point.
 - Change the direction of this unit.
 - Change the location and orientation of the wireless access point.
 - Perform the [Manual Input].
- It may not display even if the radio waves exist depending on the setting of the wireless access point.
 - Check the settings of the wireless access point.
 - When the network SSID of the wireless access point is set not to broadcast, the wireless access point may not be detected. Enter the network SSID to start the connection or enable the SSID broadcast of the wireless access point.
- Connection types and security setting methods are different depending on the wireless access point. (Refer to the operating instructions of the wireless access point.)
- Is the 5 GHz/2.4 GHz switchable wireless access point connected to other equipment using the 5 GHz band?
 - The use of a wireless access point that can use 5 GHz/2.4 GHz simultaneously is recommended. It cannot be used simultaneously with this camera if it is not compatible.

Images cannot be transmitted to a PC.

- When the firewall of the OS, security software, etc. is enabled, connecting to the PC may not be possible.

When I try to set up a Wi-Fi connection with a Windows 8 PC, my user name and password are not recognized, so I cannot connect to the PC.

- Some OS versions, including Windows 8, use two types of accounts: a local account and a Microsoft account.
 - Be sure to use the user name and password for the local account.
 - If you haven't set up a local account, please create one.

The PC is not recognized when I use a Wi-Fi connection. The camera cannot be connected to PC via Wi-Fi connection.

- The default workgroup name is set to "WORKGROUP". If you changed the workgroup name, the PC will not be recognized.
 - In [Change Workgroup Name] in [PC Connection] of the [Wi-Fi Setup] menu, change the workgroup name to that of the PC you are connecting to.
- Please confirm login name and password are correctly typed.
- When the system time of Mac computer or Windows PC connected to a camera differs severely from that of the camera, the camera cannot be connected to the computer or PC in some OSs.
 - Please confirm [Clock Set] and [World Time] of the camera matches with time, date and time zone in Windows PC or Mac computer. When both settings do not match severely, please match them.

Transmission of the image fails midway. Some images cannot be transmitted.

- Image cannot be transmitted when the battery indicator is flashing red.
- Is the size of the image too large?
 - Reduce the image size at [Size], and then send.
 - Transmit after dividing the motion picture with [Video Divide].
- File format of the motion picture that can be sent differs depending on the destination.
- Capacity or number of images in the web service is full.
 - Login to "LUMIX CLUB", and check the status of the destination on the web service link settings.

The motion pictures cannot be played back on a TV.

- Are you trying to play back the motion pictures by directly inserting the card in the card slot of the TV?
 - Connect the camera to the TV with the AV cable (optional), or with the HDMI micro cable, and then play back the motion pictures on the camera.

VIERA Link does not work.

- Is it connected properly with the HDMI micro cable?
- Is the [VIERA Link] on this unit set to [ON]?
 - If the input channel does not switch automatically, use the remote control for the TV to switch it.
 - Check the VIERA Link setting on the connected device.
 - Turn this unit off and on.
 - Set [HDAVI Control] to [Off] on the TV and then turn it back to [On].
(Refer to the operating instructions of the TV for details.)

There is a sound from lens unit.

- It is a sound of lens movement or aperture operation when this unit is turned on or off, and it is not a malfunction.
- The sound, which is caused by the automatic adjustment of the aperture, is heard when the brightness has changed due to, for example, zooming or the movement of the camera. This is not a malfunction.

The camera becomes warm.

- The surface of the camera and the reverse side of the monitor may become warm during use. This does not affect the performance or quality of the camera.

The clock is reset.

- If you do not use the camera for a long time, the clock may be reset.
 - [Please set the clock] message will be displayed; please reset the clock. (P18)

Specifications

Specifications are subject to change without notice.

Digital Camera Body (DMC-G7):

Information for your safety

Power Source:	8.4 V---
Power Consumption:	2.6 W (When recording with Monitor) [When the Interchangeable lens (H-FS1442A) is used] 2.6 W (When recording with Monitor) [When the Interchangeable lens (H-FS45150) is used] 2.7 W (When recording with Monitor) [When the Interchangeable lens (H-FS14140) is used] 2.0 W (When playing back with Monitor) [When the Interchangeable lens (H-FS1442A) is used] 2.0 W (When playing back with Monitor) [When the Interchangeable lens (H-FS45150) is used] 2.0 W (When playing back with Monitor) [When the Interchangeable lens (H-FS14140) is used]

Camera effective pixels	16,000,000 pixels
Image sensor	4/3" Live MOS sensor, Primary color filter
Digital Zoom	2×/4×
Extended Tele Conversion	When taking still pictures: Max. 2× (When a picture size of [S] (4 M), aspect ratio of [4:3] is selected.) When recording motion pictures: 2.4×/3.6×/4.8×
Focus	Auto Focus/Manual Focus, Face/Eye Detection/Tracking/49-area-focusing/Custom Multi/ 1-area-focusing/Pinpoint (Touch focus area selection possible)
Shutter type	Focal-plane shutter

Burst recording	
Burst speed	Mechanical shutter 8 pictures/second (High speed, AFS), 6 pictures/second (High speed, AFC), 6 pictures/second (Middle speed), 2 pictures/second (Low speed)
	Electronic shutter 40 pictures/second (Super high speed), 10 pictures/second (High speed), 6 pictures/second (Middle speed), 2 pictures/second (Low speed)
Number of recordable pictures	When there are RAW files: 13 or higher pictures When there are no RAW files: 100 or higher pictures * When recording is performed under the test conditions specified by Panasonic.
ISO sensitivity (Standard Output Sensitivity)	AUTO/ $\frac{1}{\square}$ ISO/100*/200/400/800/1600/3200/6400/12800/25600 (1/3 EV step change possible) * Only available when [Extended ISO] is set.
Minimum Illumination	Approx. 9 lx (when i-Low light is used, the shutter speed is 1/30th of a second) [When the Interchangeable lens (H-FS1442A) is used] Approx. 12 lx (when i-Low light is used, the shutter speed is 1/30th of a second) [When the Interchangeable lens (H-FS45150) is used] Approx. 9 lx (when i-Low light is used, the shutter speed is 1/30th of a second) [When the Interchangeable lens (H-FS14140) is used]
Shutter speed	Still picture: B (Bulb) (Max. approx. 120 seconds), 60 seconds to 1/4000th of a second (Mechanical shutter), 1 second to 1/16000th of a second (Electronic shutter) Motion picture: 1/25th of a second to 1/16000th of a second
Metering range	EV 0 to EV 18
White Balance	Auto White Balance/Daylight/Cloudy/Shade/Incandescent lights/Flash/White set1/White set2/White set3/White set4/White Balance K set

Exposure (AE)	Program AE (P)/Aperture-priority AE (A)/Shutter-priority AE (S)/ Manual exposure (M)/AUTO Exposure Compensation (1/3 EV Step, -5 EV to +5 EV)
Metering Mode	Multiple/Center weighted/Spot
Monitor	3.0" TFT LCD (3:2) (Approx. 1,040,000 dots) (field of view ratio about 100%) Touch screen
Viewfinder	OLED Live Viewfinder (4:3) (Approx. 2,360,000 dots) (field of view ratio about 100%) [Magnification approx. 1.40×, 0.70× (35 mm film camera equivalent), with 50 mm lens at infinity; -1.0 m ⁻¹] (with diopter adjustment -4 to +4 diopter)
Flash	Built-in pop up flash GN 9.3 equivalent (ISO200 · m) [GN 6.6 equivalent (ISO100 · m)] Flash range: Approx. 0.5 m (1.6 feet) to 7.5 m (25 feet) [When the Interchangeable lens (H-FS1442A) is mounted, WIDE, [ISO AUTO] is set] Approx. 0.9 m (3.0 feet) to 6.6 m (22 feet) [When the Interchangeable lens (H-FS45150) is mounted, WIDE, [ISO AUTO] is set] Approx. 0.8 m (2.6 feet) to 7.5 m (25 feet) [When the Interchangeable lens (H-FS14140) is mounted, WIDE, [ISO AUTO] is set] AUTO, AUTO/Red-Eye Reduction, Forced ON, Forced ON/ Red-Eye Reduction, Slow Sync., Slow Sync./Red-Eye Reduction, Forced OFF
Flash synchronization speed	Equal to or smaller than 1/160th of a second
Microphone	Stereo
Speaker	Monaural
Recording media	SD Memory Card/SDHC Memory Card*/SDXC Memory Card* (* UHS-I/UHS-II UHS Speed Class 3)

Picture size	
Still picture	When the aspect ratio setting is [4:3] 4592×3448 pixels, 3232×2424 pixels, 2272×1704 pixels When the aspect ratio setting is [3:2] 4592×3064 pixels, 3232×2160 pixels, 2272×1520 pixels When the aspect ratio setting is [16:9] 4592×2584 pixels, 3840×2160 pixels, 1920×1080 pixels When the aspect ratio setting is [1:1] 3424×3424 pixels, 2416×2416 pixels, 1712×1712 pixels
Recording quality	
Motion pictures	[AVCHD] 1920×1080 (FHD/60p: 28 Mbps), 60p recording/ 1920×1080 (FHD/60i: 17 Mbps), 60i recording/ 1920×1080 (FHD/30p: 24 Mbps), 60i recording*/ 1920×1080 (FHD/24p: 24 Mbps), 24p recording * Sensor output is 30 frames/sec. [MP4] 3840×2160 (4K/30p: 100 Mbps)/ 3840×2160 (4K/24p: 100 Mbps)/ 1920×1080 (FHD/60p: 28 Mbps)/ 1920×1080 (FHD/30p: 20 Mbps)/ 1280×720 (HD/30p: 10 Mbps)/ 640×480 (VGA/30p: 4 Mbps)
Quality	RAW/RAW+Fine/RAW+Standard/Fine/Standard/MPO+Fine/ MPO+Standard
Recording file format	
Still Picture	RAW/JPEG (based on "Design rule for Camera File system", based on "Exif 2.3" standard, DPOF corresponding)/MPO
Motion pictures	AVCHD Progressive/AVCHD/MP4
Audio compression	AVCHD Dolby® Digital (2 ch)
	MP4 AAC (2 ch)
Interface	
Digital	"USB 2.0" (High Speed)
Analog video/audio	NTSC Audio line output (monaural)
Terminal	
[REMOTE]	φ 2.5 mm jack
[AV OUT/DIGITAL]	Dedicated jack (8 pin)
[HDMI]	micro HDMI Type D
[MIC]	φ 3.5 mm jack

Dimensions	Approx. 124.9 mm (W)×86.2 mm (H)×77.4 mm (D) [4.92" (W)×3.39"(H)×3.05" (D)] (excluding the projecting parts)
Mass (Weight)	Approx. 410 g/0.90 lb [with the card and battery] Approx. 360 g/0.79 lb (camera body) Approx. 520 g/1.15 lb [with the Interchangeable lens (H-FS1442A), card and battery] Approx. 610 g/1.34 lb [with the Interchangeable lens (H-FS45150), card and battery] Approx. 675 g/1.49 lb [with the Interchangeable lens (H-FS14140), card and battery]
Operating temperature	0 °C to 40 °C (32 °F to 104 °F)
Operating humidity	10%RH to 80%RH
Language select	[ENGLISH]/[DEUTSCH]/[FRANÇAIS]/[ESPAÑOL]/ [PORTUGUÊS]/[ITALIANO]/[繁體中文]/[日本語]

Wireless transmitter

Compliance standard	IEEE 802.11b/g/n (standard wireless LAN protocol)
Frequency range used (central frequency)	2412 MHz to 2462 MHz (1 to 11ch)
Encryption method	Wi-Fi compliant WPA™/WPA2™
Access method	Infrastructure mode

Battery Charger (Panasonic DE-A79B):

Information for your safety

Input:	110 V–240 V ~ 50/60 Hz 0.2 A
Output:	8.4 V === 0.65 A

Equipment mobility:

Movable

Battery Pack (lithium-ion) (Panasonic DMW-BLC12PP):

Information for your safety

Voltage/capacity:	7.2 V/1200 mAh
--------------------------	----------------

The symbols on this product (including the accessories) represent the following:

~	AC
===	DC
□	Class II equipment (The construction of the product is double-insulated.)

Interchangeable Lens	H-FS1442A “LUMIX G VARIO 14–42 mm/ F3.5–5.6 II ASPH./MEGA O.I.S.”	H-FS45150 “LUMIX G VARIO 45–150 mm/ F4.0–5.6 ASPH./MEGA O.I.S.”
Focal length	f=14 mm to 42 mm (35 mm film camera equivalent: 28 mm to 84 mm)	f=45 mm to 150 mm (35 mm film camera equivalent: 90 mm to 300 mm)
Aperture type	7 diaphragm blades/circular aperture diaphragm	7 diaphragm blades/circular aperture diaphragm
Aperture range	F3.5 (Wide) to F5.6 (Tele)	F4.0 (Wide) to F5.6 (Tele)
Minimum aperture value	F22	F22
Lens construction	9 elements in 8 groups (2 aspherical lenses)	12 elements in 9 groups (2 aspherical lenses, 1 UHR Lens)
In focus distance	0.2 m (0.66 feet) to ∞ (from the focus distance reference line) (focal length 14 mm to 20 mm), 0.3 m (0.98 feet) to ∞ (from the focus distance reference line) (focal length 21 mm to 42 mm)	0.9 m (3.0 feet) to ∞ (from the focus distance reference line)
Maximum image magnification	0.17× (35 mm film camera equivalent: 0.34×)	0.17× (35 mm film camera equivalent: 0.35×)
Optical Image Stabilizer	Available	Available
[O.I.S.] switch	None (Setting of the [Stabilizer] is done in [Rec] menu.)	None (Setting of the [Stabilizer] is done in [Rec] menu.)
Mount	“Micro Four Thirds Mount”	“Micro Four Thirds Mount”
Angle of view	75° (Wide) to 29° (Tele)	27° (Wide) to 8.2° (Tele)
Filter diameter	46 mm	52 mm
Max. diameter	Approx. 56 mm (2.2 inch)	Approx. 62 mm (2.4 inch)
Overall length	Approx. 49 mm (1.9 inch) (from the tip of the lens to the base side of the lens mount)	Approx. 73 mm (2.9 inch) (from the tip of the lens to the base side of the lens mount)
Mass (Weight)	Approx. 110 g/0.24 lb	Approx. 200 g/0.44 lb

Interchangeable Lens	H-FS14140 “LUMIX G VARIO 14–140 mm/F3.5–5.6 ASPH./POWER O.I.S.”
Focal length	f=14 mm to 140 mm (35 mm film camera equivalent: 28 mm to 280 mm)
Aperture type	7 diaphragm blades/circular aperture diaphragm
Aperture range	F3.5 (Wide) to F5.6 (Tele)
Minimum aperture value	F22
Lens construction	14 elements in 12 groups (3 aspherical lenses, 2 ED lenses)
In focus distance	0.3 m (0.98 feet) to ∞ (from the focus distance reference line) (focal length 14 mm to 21 mm), 0.5 m (1.6 feet) to ∞ (from the focus distance reference line) (focal length 22 mm to 140 mm)
Maximum image magnification	0.25 \times (35 mm film camera equivalent: 0.5 \times)
Optical Image Stabilizer	Available
[O.I.S.] switch	Available (Switching ON/OFF)
Mount	“Micro Four Thirds Mount”
Angle of view	75° (Wide) to 8.8° (Tele)
Filter diameter	58 mm
Max. diameter	Approx. 67 mm (2.6 inch)
Overall length	Approx. 75 mm (3.0 inch) (from the tip of the lens to the base side of the lens mount)
Mass (Weight)	Approx. 265 g/0.58 lb

Digital Camera Accessory System

Description	Accessory#
Battery Pack	DMW-BLC12
AC Adaptor ^{*1}	DMW-AC10
DC Coupler ^{*1}	DMW-DCC8
LED Video Light	VW-LED1
Flash	DMW-FL360L, DMW-FL580L
Stereo Shotgun Microphone	DMW-MS2
Stereo Microphone	VW-VMS10
Remote Shutter	DMW-RSL1
Body Cap	DMW-BDC1
Tripod Adaptor ^{*2}	DMW-TA1
USB connection Cable	DMW-USBC1
AV Cable	DMW-AVC1
Mount Adaptor	DMW-MA1, DMW-MA2M, DMW-MA3R

*1 The AC Adaptor (optional) can only be used with the designated Panasonic DC Coupler (optional). The AC adaptor (optional) cannot be used by itself.

*2 Use if the attached lens is in contact with the tripod pedestal.

Product numbers correct as of May 2015. These may be subject to change.

- Some optional accessories may not be available in some countries.
- NOTE: Accessories and/or model numbers may vary between countries. Consult your local dealer.
- For lens-related optional accessories such as compatible lenses and filters, refer to catalogs/ Web pages, etc.

Reading the Owner's Manual (PDF format)

More detailed instructions on the operation of this camera are contained in "Owner's Manual for advanced features (PDF format)" in the supplied DVD.

■ For Windows

- 1 Turn the PC on and insert the DVD containing the Owner's Manual (supplied).**
 - If the automatic playback screen is displayed, you can display the menu by selecting and executing [Launcher.exe].
 - In Windows 8/Windows 8.1, you can display the menu by clicking a message that is displayed after inserting the DVD and then selecting and executing [Launcher.exe].
 - You can also display the menu by double-clicking [SFMXXXX] in [Computer] (XXXX differs depending on the model).
- 2 Click the [Owner's Manual].**
 - The list of Owner's Manual (PDF format) will be displayed.
- 3 Click the language of the Owner's Manual you want to open.**
 - The "Owner's Manual for advanced features (PDF format)" will open.
You can save the "Owner's Manual for advanced features" on the PC.

- You will need Adobe Reader to browse or print the "Owner's Manual for advanced features (PDF format)".

You can download and install a version of Adobe Reader that you can use with your OS from the following website. (As of May 2015)

<http://www.adobe.com/products/acrobat/readstep2.html>

■ For Mac

- 1 Turn the PC on and insert the DVD containing the Owner's Manual (supplied).**
- 2 Open the "Manual" folder in the DVD.**
- 3 Double click the [INDEX.pdf].**
 - The list of Owner's Manual (PDF format) will be displayed.
- 4 Click the language of the Owner's Manual you want to open.**
 - The "Owner's Manual for advanced features (PDF format)" will open.
You can save the "Owner's Manual for advanced features" on the PC.

- You can also open the "Owner's Manual for advanced features (PDF format)" directly from the "Manual" folder.

Limited Warranty (ONLY FOR U.S.A.)

Panasonic Products Limited Warranty

Limited Warranty Coverage (For USA Only)

If your product does not work properly because of a defect in materials or workmanship, Panasonic Corporation of North America (referred to as “the warrantor”) will, for the length of the period indicated on the chart below, which starts with the date of original purchase (“warranty period”), at its option either (a) repair your product with new or refurbished parts, (b) replace it with a new or a refurbished equivalent value product, or (c) refund your purchase price. The decision to repair, replace or refund will be made by the warrantor.

Product or Part Name	Parts	Labor
Digital Camera	1 Year	1 Year
All included Accessories (Except Non-Rechargeable Batteries)	90 Days	Not Applicable
Only Non-Rechargeable Batteries	10 Days	Not Applicable

During the “Labor” warranty period there will be no charge for labor. During the “Parts” warranty period, there will be no charge for parts. This Limited Warranty excludes both parts and labor for non-rechargeable batteries, antennas, and cosmetic parts (cabinet). This warranty only applies to products purchased and serviced in the United States. This warranty is extended only to the original purchaser of a new product which was not sold “as is”.

Mail-In Service--Online Repair Request

Online Repair Request

To submit a new repair request and for quick repair status visit our Web Site at <http://shop.panasonic.com/support>.

When shipping the unit, carefully pack, include all supplied accessories listed in the Owner's Manual, and send it prepaid, adequately insured and packed well in a carton box. When shipping Lithium Ion batteries please visit our Web Site at <http://shop.panasonic.com/support> as Panasonic is committed to providing the most up to date information. Include a letter detailing the complaint, a return address and provide a daytime phone number where you can be reached. A valid registered receipt is required under the Limited Warranty.

IF REPAIR IS NEEDED DURING THE WARRANTY PERIOD, THE PURCHASER WILL BE REQUIRED TO FURNISH A SALES RECEIPT/PROOF OF PURCHASE INDICATING DATE OF PURCHASE, AMOUNT PAID AND PLACE OF PURCHASE. CUSTOMER WILL BE CHARGED FOR THE REPAIR OF ANY UNIT RECEIVED WITHOUT SUCH PROOF OF PURCHASE.

Limited Warranty Limits and Exclusions

This warranty ONLY COVERS failures due to defects in materials or workmanship, and DOES NOT COVER normal wear and tear or cosmetic damage. The warranty ALSO DOES NOT COVER damages which occurred in shipment, or failures which are caused by products not supplied by the warrantor, or failures which result from accidents, misuse, abuse, neglect, mishandling, misapplication, alteration, faulty installation, set-up adjustments, misadjustment of consumer controls, improper maintenance, power line surge, lightning damage, modification, introduction of sand, humidity or liquids, commercial use such as hotel, office, restaurant, or other business or rental use of the product, or service by anyone other than a Factory Service Center or other Authorized Servicer, or damage that is attributable to acts of God.

THERE ARE NO EXPRESS WARRANTIES EXCEPT AS LISTED UNDER “LIMITED WARRANTY COVERAGE”.

THE WARRANTOR IS NOT LIABLE FOR INCIDENTAL OR CONSEQUENTIAL DAMAGES RESULTING FROM THE USE OF THIS PRODUCT, OR ARISING OUT OF ANY BREACH OF THIS WARRANTY.

(As examples, this excludes damages for lost time, travel to and from the servicer, loss of or damage to media or images, data or other memory or recorded content. The items listed are not exclusive, but for illustration only.)

ALL EXPRESS AND IMPLIED WARRANTIES, INCLUDING THE WARRANTY OF MERCHANTABILITY, ARE LIMITED TO THE PERIOD OF THE LIMITED WARRANTY.

Some states do not allow the exclusion or limitation of incidental or consequential damages, or limitations on how long an implied warranty lasts, so the exclusions may not apply to you. This warranty gives you specific legal rights and you may also have other rights which vary from state to state. If a problem with this product develops during or after the warranty period, you may contact your dealer or Service Center. If the problem is not handled to your satisfaction, then write to:

Consumer Affairs Department
Panasonic Corporation of North America
661 Independence Pkwy
Chesapeake, VA 23320

PARTS AND SERVICE, WHICH ARE NOT COVERED BY THIS LIMITED WARRANTY, ARE YOUR RESPONSIBILITY.

Shop
Accessories!

for all your Panasonic gear

Go to

<http://shop.panasonic.com/support>

Get everything you need to get the most out of
your Panasonic products

Accessories & Parts for your Camera, Phone, A/V
products, TV, Computers & Networking, Personal
Care, Home Appliances, Headphones, Batteries,
Backup Chargers & more...

Customer Services Directory

For Product Information, Operating Assistance,
Parts, Owner's Manuals, Dealer and Service info
go to <http://shop.panasonic.com/support>

For the hearing or speech impaired TTY: 1- 877-833-8855

As of July 2015

Limited Warranty (ONLY FOR CANADA)

Panasonic Canada Inc.

5770 Ambler Drive, Mississauga, Ontario L4W 2T3

PANASONIC PRODUCT – LIMITED WARRANTY

Panasonic Canada Inc. warrants this product to be free from defects in material and workmanship under normal use and for a period as stated below from the date of original purchase agrees to, at its option either (a) repair your product with new or refurbished parts, (b) replace it with a new or a refurbished equivalent value product, or (c) refund your purchase price. The decision to repair, replace or refund will be made by Panasonic Canada Inc.

Digital Camera	One (1) year, parts and labour
Digital Camera Peripherals	One (1) year, parts and labour
Digital Camera Accessories	Ninety (90) days, parts and labour

This warranty is given only to the original purchaser, or the person for whom it was purchased as a gift, of a Panasonic brand product mentioned above sold by an authorized Panasonic dealer in Canada and purchased and used in Canada, which product was not sold "as is", and which product was delivered to you in new condition in the original packaging.

IN ORDER TO BE ELIGIBLE TO RECEIVE WARRANTY SERVICE HEREUNDER, A PURCHASE RECEIPT OR OTHER PROOF OF DATE OF ORIGINAL PURCHASE, SHOWING AMOUNT PAID AND PLACE OF PURCHASE IS REQUIRED

LIMITATIONS AND EXCLUSIONS

This warranty ONLY COVERS failures due to defects in materials or workmanship, and DOES NOT COVER normal wear and tear or cosmetic damage. The warranty ALSO DOES NOT COVER damages which occurred in shipment, or failures which are caused by products not supplied by Panasonic Canada Inc., or failures which result from accidents, misuse, abuse, neglect, mishandling, misapplication, alteration, faulty installation, set-up adjustments, misadjustment of consumer controls, improper maintenance, improper batteries, power line surge, lightning damage, modification, introduction of sand, humidity or liquids, commercial use such as hotel, office, restaurant, or other business or rental use of the product, or service by anyone other than a Authorized Servicer, or damage that is attributable to acts of God.

Dry cell batteries, printer ink cartridge and paper are also excluded from coverage under this warranty.

Rechargeable batteries are warranted for ninety (90) days from date of original purchase.

THIS EXPRESS, LIMITED WARRANTY IS IN LIEU OF ALL OTHER WARRANTIES, EXPRESS OR IMPLIED, INCLUDING ANY IMPLIED WARRANTIES OF MERCHANTABILITY AND FITNESS FOR A PARTICULAR PURPOSE. IN NO EVENT WILL PANASONIC CANADA INC. BE LIABLE FOR ANY SPECIAL, INDIRECT OR CONSEQUENTIAL DAMAGES RESULTING FROM THE USE OF THIS PRODUCT OR ARISING OUT OF ANY BREACH OF ANY EXPRESS OR IMPLIED WARRANTY. (As examples, this warranty excludes damages for lost time, travel to and from the Authorized Servicer, loss of or damage to media or images, data or other memory or recorded content. This list of items is not exhaustive, but for illustration only.)

In certain instances, some jurisdictions do not allow the exclusion or limitation of incidental or consequential damages, or the exclusion of implied warranties, so the above limitations and exclusions may not be applicable. This warranty gives you specific legal rights and you may have other rights which vary depending on your province or territory.

WARRANTY SERVICE

For product operation, repairs and information assistance, please visit our Support page:

www.panasonic.ca/english/support

This product incorporates the following software:

- (1) the software developed independently by or for Panasonic Corporation,
- (2) the software owned by third party and licensed to Panasonic Corporation, and/or
- (3) open source software

The software categorized as (3) is distributed in the hope that it will be useful, but WITHOUT ANY WARRANTY, without even the implied warranty of MERCHANTABILITY or FITNESS FOR A PARTICULAR PURPOSE.

Please refer to the detailed terms and conditions thereof displayed by selecting [MENU/SET] → [Setup] → [Version Disp.] → [Software info].

- G MICRO SYSTEM is a lens exchange type digital camera system of LUMIX based on a Micro Four Thirds System standard.
- Micro Four Thirds™ and Micro Four Thirds Logo marks are trademarks or registered trademarks of Olympus Corporation, in Japan, the United States, the European Union and other countries.
- Four Thirds™ and Four Thirds Logo marks are trademarks or registered trademarks of Olympus Corporation, in Japan, the United States, the European Union and other countries.
- SDXC Logo is a trademark of SD-3C, LLC.
- "AVCHD", "AVCHD Progressive" and the "AVCHD Progressive" logo are trademarks of Panasonic Corporation and Sony Corporation.
- Manufactured under license from Dolby Laboratories. Dolby and the double-D symbol are trademarks of Dolby Laboratories.
- HDMI, the HDMI Logo, and High-Definition Multimedia Interface are trademarks or registered trademarks of HDMI Licensing LLC in the United States and other countries.
- HDAVI Control™ is a trademark of Panasonic Corporation.
- Adobe is a trademark or registered trademark of Adobe Systems Incorporated in the United States and/or other countries.
- Pentium is a trademark of Intel Corporation in the U.S. and/or other countries.
- iMovie, Mac and Mac OS are trademarks of Apple Inc., registered in the U.S. and other countries.
- iPad, iPhone, iPod, and iPod touch are trademarks of Apple Inc., registered in the U.S. and other countries.
- App Store is a service mark of Apple Inc.
- Windows and Windows Vista are either registered trademarks or trademarks of Microsoft Corporation in the United States and/or other countries.



- Android and Google Play are trademarks or registered trademarks of Google Inc.
- The Wi-Fi CERTIFIED™ Logo is a certification mark of Wi-Fi Alliance®.
- The Wi-Fi Protected Setup™ Identifier mark is a certification mark of Wi-Fi Alliance®.
- “Wi-Fi®” and “Wi-Fi Direct®” are registered trademarks of Wi-Fi Alliance®.
- “Wi-Fi Protected Setup™”, “WPA™”, and “WPA2™” are trademarks of Wi-Fi Alliance®.
- DLNA, the DLNA Logo and DLNA CERTIFIED are trademarks, service marks, or certification marks of the Digital Living Network Alliance.
- This product uses “DynaFont” from DynaComware Corporation. DynaFont is a registered trademark of DynaComware Taiwan Inc.
- QR Code is a registered trademark of DENSO WAVE INCORPORATED.
- Other names of systems and products mentioned in these instructions are usually the registered trademarks or trademarks of the manufacturers who developed the system or product concerned.



This product is licensed under the AVC patent portfolio license for the personal and non-commercial use of a consumer to (i) encode video in compliance with the AVC Standard (“AVC Video”) and/or (ii) decode AVC Video that was encoded by a consumer engaged in a personal and non-commercial activity and/or was obtained from a video provider licensed to provide AVC Video. No license is granted or shall be implied for any other use. Additional information may be obtained from MPEG LA, LLC. See <http://www.mpegla.com> .

Panasonic Corporation of North America
Two Riverfront Plaza, Newark, NJ 07102-5490
<http://shop.panasonic.com>

Panasonic Canada Inc.
5770 Ambler Drive, Mississauga, Ontario L4W 2T3
www.panasonic.com

© Panasonic Corporation 2015

Printed in China